

Final Report  
**Vol. I Agricultural Scene Understanding  
and Supporting Field Research**

by **M. E. Bauer**  
**L. L. Biehl**  
**C. S. T. Daughtry**  
**B. F. Robinson**  
**E. R. Stoner**

Principal Investigator  
**D. A. Landgrebe**

**November 1979**

Prepared for  
**National Aeronautics and Space Administration**

Johnson Space Center  
Earth Observation Division  
Houston, Texas 77058  
Contract No. NAS9-15466  
Technical Monitor: J. D. Erickson/SF3

Submitted by  
**Laboratory for Applications of Remote Sensing**  
**Purdue University**  
**West Lafayette, Indiana 47907**

1. Report No. SR-P9-00410		2. Government Accession No.		3. Recipient's Catalog No.	
4. Title and Subtitle  Vol. I Agricultural Scene Understanding and Supporting Field Research				5. Report Date November 30, 1979	
				6. Performing Organization Code	
7. Author(s) M.E. Bauer, L.L. Biehl, C.S.T. Daughtry, B.F. Robinson and E.R. Stoner				8. Performing Organization Report No. 112879	
9. Performing Organization Name and Address Purdue University Laboratory for Applications of Remote Sensing 1220 Potter Drive West Lafayette, Indiana 47906				10. Work Unit No.	
				11. Contract or Grant No. NAS9-15466	
12. Sponsoring Agency Name and Address NASA/Johnson Space Center Houston, Texas 77058				13. Type of Report and Period Covered Final 12/1/78-11/30/79	
				14. Sponsoring Agency Code	
15. Supplementary Notes Principal Investigator: D.A. Landgrebe Technical Monitor: J.D. Erickson					
16. Abstract  Results of several investigations, all related to increasing our understanding of the spectral properties of crops and soils are described. The following topics are addressed:  A. Field research experiment design and data analysis, B. Field research data acquisition and preprocessing, C. Development of multiband radiometer, D. Establishment of soils data base, E. Field research data base management and software development, F. Evaluation of calibration procedures for measurement of bidirectional reflectance factor in remote sensing field research.					
17. Key Words (Suggested by Author(s)) Remote sensing, multispectral, radiation properties of crops and soils, field research, reflectance, radiometer				18. Distribution Statement	
19. Security Classif. (of this report) Unclassified		20. Security Classif. (of this page) Unclassified		21. No. of Pages 131	22. Price*

## **NOTICE**

THIS DOCUMENT HAS BEEN REPRODUCED FROM  
MICROFICHE. ALTHOUGH IT IS RECOGNIZED THAT  
CERTAIN PORTIONS ARE ILLEGIBLE, IT IS BEING RELEASED  
IN THE INTEREST OF MAKING AVAILABLE AS MUCH  
INFORMATION AS POSSIBLE

# AgRISTARS

80-10113

SR-P9-00410

NAS9-15466

NASA CR-

160547

*"...available under NASA sponsorship  
...interest of early and wide dis-  
...of Earth Resources Survey  
...information and without benefit  
...made thereof."*

A Joint Program for  
Agriculture and  
Resources Inventory  
Surveys Through  
Aerospace  
Remote Sensing

## Supporting Research

November 1979

---

Final Report

## Vol. I Agricultural Scene Understanding and Supporting Field Research

by M. E. Bauer, L. L. Biehl, C. S. T. Daughtry, B. F. Robinson and  
E. R. Stoner

(E80-10113) AGRICULTURAL SCENE  
UNDERSTANDING AND SUPPORTING FIELD RESEARCH,  
VOLUME 1 Final Report, 1 Dec. 1978 - 30  
Nov. 1979 (Purdue Univ.) 140 p  
HC A07/MF A01

N80-23740

Unclas

CSCL 02C G3/43 00113

Laboratory for Applications of Remote Sensing  
Purdue University  
West Lafayette, Indiana 47907



NASA



SR-P9-00410  
NAS9-15466  
LARS 112879

FINAL REPORT  
VOL. I AGRICULTURAL SCENE UNDERSTANDING AND  
SUPPORTING FIELD RESEARCH

BY

M.E. Bauer, L.L. Biehl, C.S.T. Daughtry, B.F. Robinson, E.R. Stoner

The research reported here was initiated during the planning phases of the AgRISTARS Supporting Research Project and, although it stands on its own merit, it benefits the Supporting Research Project and became a part of those plans.

Purdue University  
Laboratory for Applications of Remote Sensing  
West Lafayette, Indiana 47906

November 1979

## TABLE OF CONTENTS

	Page
List of Tables . . . . .	1
List of Figures . . . . .	11
A. Field Research Experiment Design and Data Analysis . . . . .	1
1. Field Research Experiment Design . . . . .	5
2. Data Analysis . . . . .	12
B. Field Research Data Acquisition and Preprocessing. . . . .	24
1. Purdue Agronomy Farm Experiments . . . . .	24
2. Data Acquisition and Preprocessing for Other Test Sites. . . . .	43
C. Development of Multiband Radiometer System . . . . .	47
1. Introduction . . . . .	47
2. Description of the Multiband Radiometer. . . . .	48
3. Description of Data Recording Module . . . . .	53
4. Construction of Truck-Mounted Boom . . . . .	56
5. System and Users Manuals . . . . .	59
6. Development of Data Handling Software. . . . .	59
7. Interface Hardware and Software. . . . .	65
D. Establishment of Soils Data Base . . . . .	66
1. Introduction . . . . .	66
2. Study Objectives . . . . .	67
3. Experimental Approach. . . . .	68
4. Soil Properties Data Base. . . . .	70
5. Numerical Analysis . . . . .	84
6. References . . . . .	91
E. Field Research Data Base Management and Software Development . . . . .	93
1. Field Research Data Library and Distribution . . . . .	94
2. Data Analysis Software Development and Documentation . . . . .	103
3. Data Processing Software Development . . . . .	105
F. Evaluation of Calibration Procedures for Measurement of Bidirectional Reflectance Factor in Remote Sensing Field Research. . . . .	109
1. Introduction . . . . .	109
2. Bidirectional Reflectance Factor (BRF) . . . . .	109
3. Discussion of the approach . . . . .	111
4. Field Procedures . . . . .	112

Table of Contents Cont'd

	Page
5. Reference Surfaces . . . . .	.112
6. Effects of Non-Directional Illumination. . . . .	.115
7. Comparison of Spectral Bidirectional Reflectance Factor Measurements made by Three Spectrometer Systems. . . . .	.125
8. Conclusions. . . . .	.130
9. References . . . . .	.130

## LIST OF TABLES

	<u>Page</u>
A-1. Outline of Supporting Field Research project plan . . . . .	7
B-1. Summary of the 1979 Supporting Field Research Experiments at the Purdue Agronomy Farm . . . . .	26
B-2. Summary of spectral measurements collected at the Purdue Agronomy Farm for the 1979 field research experiments . . . . .	38
B-3. Summary of agronomic measurements collected at the Purdue Agronomy Farm for the 1979 field research experiments . . . . .	40
B-4. Summary of 1979 data acquisition by the Exotech 20C spectro- radiometer system at the Purdue Agronomy Farm . . . . .	41
B-5. Summary of 1979 data acquisition by the Exotech 100 field radiometer system at the Purdue Agronomy Farm . . . . .	42
B-6. Summary of 1979 crop year data acquisition by the NASA/JSC helicopter-mounted field spectrometer system (FSS) . . . . .	45
B-7. Summary of 1979 crop year data acquisition by the NASA/JSC aircraft multispectral scanners . . . . .	46
C-1. Spectral band specification . . . . .	49
D-1. Soil spectral bands for correlation analysis . . . . .	84
D-2. Simple correlation coefficients between five soil parameters and reflectance in individual bands for all soils and for soils grouped by moisture zone and by temperature regime . . . . .	85
D-3. Simple correlation coefficients between five soil parameters and reflectance in individual bands by climatic zone . . . . .	86
D-4. Physicochemical and site characteristics as predictors of reflectance in individual spectral bands . . . . .	88
D-5. Soil reflectances in individual bands as predictors of soil parameters within certain climatic zones . . . . .	89
E-1. Summary of field research test site locations and major crops . .	96
E-2. Summary of field research controlled experimental plot test sites and commercial field test sites . . . . .	97
E-3. Summary of major sensor systems used for field research . . . . .	98
E-4. Summary and status of spectral data in the field research data library by instrument and data type . . . . .	99
E-5. Summary of recipients of field research data . . . . .	101
F-1. Determination of the variation ( $K_1K_2$ ) of the measured bidirectional reflectance factor from the true bidirectional reflectance factor . . . . .	123



LIST OF FIGURES

	Page
A-1. The role of field research in the development and application of remote sensing technology. . . . .	4
A-2. Schematic illustration of multistage approach to multicrop field research data acquisition. . . . .	10
A-3. Locations of 1979 Supporting Field Research test sites . . . . .	11
A-4. Relationship of red and near infrared reflectance of three soybean cultivars canopy reflectance as a function of measurement date. . . . .	14
A-5. Effect of row width on soybean canopy reflectance as a function of measurement date. . . . .	15
A-6. Correlation of red and near infrared reflectance with percent soil cover of soybean canopies. . . . .	16
A-7. Comparison of actual measurements of percent soil cover of soybean canopies with that predicted from reflectance measurements. . . . .	17
A-8. Effect of nitrogen fertilization level on the spectral reflectance of corn canopies. . . . .	20
A-9. Effect of nitrogen fertilization on percent soil cover, leaf area index, fresh biomass and plant nitrogen content of corn canopies as a function of measurement date. . . . .	21
A-10. Effect of nitrogen fertilization on the red and near infrared reflectance of corn canopies as a function of measurement date. . . . .	22
A-11. Relationship of plant nitrogen and leaf area index to reflectance of corn canopies. . . . .	23
B-1. Design and treatment descriptions of the 1979 Purdue Agronomy Farm corn cultural practices experiment. . . . .	28
B-2. Design and treatment descriptions of the 1979 Purdue Agronomy Farm soybean cultural practices experiment . . . . .	29
B-3. Design and treatment descriptions of the 1979 Purdue Agronomy Farm corn nitrogen fertilization experiment. . . . .	32
B-4. Design and treatment descriptions of the 1979 Purdue Agronomy Farm corn disease experiment . . . . .	33
B-5. Design and treatment descriptions of the 1979 Purdue Agronomy Farm Winter Wheat nitrogen fertilization and disease experiment. . . . .	35

Figures cont'd	Page
C-1. Sketch of Multiband Radiometer . . . . .	48
C-2. Spectral distribution of passbands superimposed on a typical vegetation spectrum. . . . .	49
C-3. Optical/electronic module of multiband radiometer . . . . .	50
C-4. Chopping arrangement for the multiband radiometer. . . . .	51
C-5. Sketch of front panel of data recording module . . . . .	55
C-6. Positioning of the pick-up truck-mounted boom . . . . .	57
C-7. Sketch of pick-up truck-mounted boom . . . . .	58
C-8. Multiband radiometer data sheet. . . . .	61
C-9. Multiband radiometer data calibration sheet . . . . .	62
C-10. Multiband radiometer data record sheet . . . . .	63
C-11. Table of contents for multiband radiometer reformatting software manual. . . . .	64
D-1. Climatic zones in the continental United States as identified by soil temperature regime (Soil Survey Staff, 1975; FAO-UNESCO, 1975) and the Thornthwaite (1948) moisture index. . . . .	69
D-2. Spectral curves representing the standard deviations from the average reflectance values for twenty check samples of a silt loam Alfisol measured over ten different laboratory setups . . . . .	71
D-3. Numbered guide corresponding to narrative key to soil information. . . . .	73
D-4. Reflectance curves, soil test results, and site characteristics in the soil data base. . . . .	74
E-1. Organization of field research data library. LARSPEC and LARSYS are Purdue/LARS software systems to analyze spectrometer/radiometer and multispectral scanner data . . . . .	95
E-2. Table of contents of LARSPEC User's Manual . . . . .	106
E-3. Example of 3-dimensional line type plot using 3-D Graphics Compatibility System Software. This plot is a temporal (growth stage) plot of three Thematic Mapper bands for corn. . . . .	107

Figures cont'd	Page
E-4. Example of 3-dimensional surface type plot using 3-D Graphics Compatibility System Software. This plot represents the joint density function for two channels and six classes in a LARSYS statistics deck for Skylab data . . . . .	.108
F-1. Truck-mounted multiband radiometer viewing a soybean canopy . . . . .	.113
F-2. Multiband radiometer positioned over painted barium sulfate reflectance panel for field reflectance calibration . . . . .	.113
F-3. Spectral bidirectional reflectance factor of three reference surfaces used for field research. . . . .	.114
F-4. Bidirectional reflectance factor at 0.6 $\mu\text{m}$ , for several incident angles, $\theta$ , and reference surfaces. Polar coordinates. . . . .	.114
F-5. Spectral bidirectional reflectance factor of painted barium sulfate for several incident angles (view angle is normal) . . . . .	.116
F-6. Spectral bidirectional reflectance factor of a canvas panel for several incident angles (view angle is normal). . . . .	.116
F-7. Bidirectional reflectance factor calibration transfer of reference surfaces used for agricultural field research . . . . .	.117
F-8. Comparison of the functions $\hat{f}_t$ and $\frac{\rho}{t}$ as a function of illumination angle, $\theta$ . . . . . $\pi$ . . . . .	.121
F-9. Polar plot of comparison of relative response of a normal viewing instrument to a scene characterized by $f_t$ and a Lambertian scene as a function of illumination angle, $\theta$ . . . . .	.121
F-10. Plot of the fractional difference between $\hat{f}_t$ and $\frac{\rho}{t}$ , $K_1$ , as a function of illumination angle, $\theta$ . . . . . $\pi$ . . . . .	.123
F-11. Purdue/LARS Exotech 20C (left) and NASA/JSC FSAS (right) spectrometer systems viewing canvas panel . . . . .	.127
F-12. NASA/JSC field spectrometer system (FSS) viewing canvas reference panel . . . . .	.127
F-13. Comparison of reflectance measurements of canvas panels by three field spectrometer systems. . . . .	.128
F-14. Pariwise comparison of reflectance measurements of canvas panels by three field spectrometer systems at three wavelengths . . . . .	.129

## A. FIELD RESEARCH EXPERIMENT DESIGN AND DATA ANALYSIS\*

Marvin E. Bauer

Major advancements have been made in recent years in the capability to acquire, process, and interpret remotely sensed multispectral measurements of the energy reflected and emitted from crops, soils, and other earth surface features. As a result of experiments such as the Large Area Crop Inventory Experiment (LACIE), the technology is moving rapidly toward operational applications (1). There is, however, a continuing need for more quantitative knowledge of the multispectral characteristics of crops and soils if further advancements in technology development and application are to be made.

Understanding of the relationships between the spectral characteristics and important biological-physical parameters of earth surface features can best be obtained by carefully controlled studies over fields and plots where complete data describing the condition of targets are attainable and where frequent, timely spectral measurements can be obtained. It is these attributes which distinguish field research from other remote sensing research activities.

In 1975, field research activities in support of LACIE were initiated (2). Spectral, agronomic, and meteorological measurements were made at LACIE test sites in Kansas, South Dakota and North Dakota for three years. The remote sensing measurements include data acquired by truck-mounted spectrometers, a helicopter-borne spectrometer, airborne multispectral scanners, and the Landsat multispectral scanners (MSS). These data were supplemented by an extensive set of agronomic and meteorological data acquired during each mission.

---

\*The contributions of Larry Biehl, Craig Daughtry, Marilyn Hixson, Jeff Kollenkark, Barrett Robinson, Vern Vanderbilt and Greg Walburg to Task 1A, Experiment Design and Data Analysis, are gratefully acknowledged.

The LACIE Field Measurements data form one of the most complete and best documented data sets acquired for agricultural remote sensing research. Thus, they are well-suited to serve as a data base for research to: (1) quantitatively determine the relationship of spectral to agronomic characteristics of crops, (2) define future sensor systems, and (3) develop advanced data analysis techniques. The data base, which has become an integral part of the Supporting Research and Technology (SR&T) data base, is unique in the comprehensiveness of sensors and missions over the same sites throughout several growing seasons and in the calibration of all multispectral data to a common standard.

Analyses of the field data have provided insight into the spectral properties and spectral identification and assessment of crops. The analyses have included investigations of the spectral separability of barley and spring wheat; determination of the effects of cultural and environmental factors on the spectral reflectance of wheat; development of predictive relationships between spectral and agronomic variables related to wheat growth and yield; and comparisons of Landsat MSS and thematic mapper spectral bands for crop identification and assessment.

As we look ahead to building as part of the AgRISTARS program (3) a capability for new and improved agricultural applications utilizing remote sensing techniques, it is important to begin to conduct the field research required to understand as quantitatively as possible the spectral characteristics of crops other than wheat, such as corn, soybeans, rice, sorghum, barley, sunflowers and cotton. It is with this background that a supporting field research element has been included in the AgRISTARS Supporting Research Project.

The objective of this task has been to: (1) design a multiyear technical program of Supporting Field Research which will result in broadly applicable quantitative and predictive relations between crop reflectance and emittance spectra and crop attributes of interest and (2) perform initial data analyses to support objective 1. An overview of the experimental approach for supporting field research is shown in Figure A-1.

The remainder of this chapter summarizes the Supporting Field Research project plan developed during 1979 and describes the initial results of two analyses of the reflectance properties of corn and soybeans. Several additional aspects of the field research project are described in other sections of this report.

#### References

1. MacDonald, R.B., and F.G. Hall. 1978. LACIE: An Experiment in Global Crop Forecasting. Proc. Plenary Session, LACIE Symp., Houston, Texas, October 23-26, pp. 17-48.
2. \_\_\_\_\_. 1979. AgRISTARS: A Joint Program for Agriculture and Resources through Aerospace Remote Sensing.
3. Bauer, M.E., M.C. McEwen, W.A. Malila, and J.C. Harlan. 1978. Design, Implementation, and Results of LACIE Field Research. Proc. LACIE Symp., Houston, Texas, October 23-26, pp. 1037-1066.

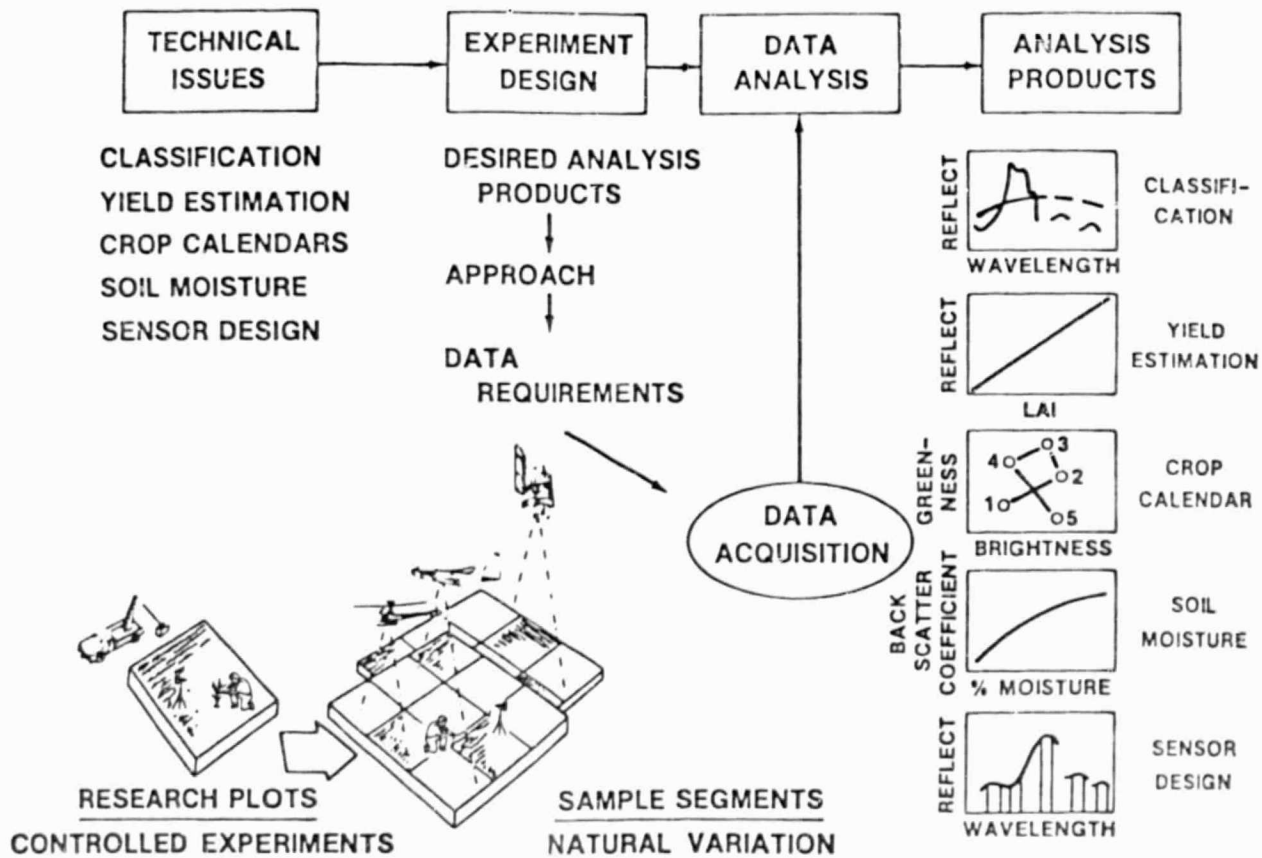

Figure A-1. The role of field research in the development and application of remote sensing technology.

## 1. Field Research Experiment Design

In this section the objectives and experimental approach for Supporting Field Research are described. An outline of the project plan developed in 1979 is presented in Table A-1 as a summary of the plan; the length of the plan (75 pages) does not permit its inclusion in this report.

### 1.1 Objectives

The overall objectives of the multicrop supporting field research are to design, acquire and make available well-documented spectral data sets with detailed agronomic and physical observations. The data will be used for analysis and modeling to obtain a quantitative understanding of the radiation characteristics of crops and their soil backgrounds and to assess the capability of current, planned and future satellite systems to capture available useful spectral information. Specific research objectives for which research was initiated in 1979 are:

- Determine the relationship of crop growth and development stages to the reflectance and radiant temperature characteristics of corn and soybeans.
- Evaluate the potential for estimating from spectral measurements important agronomic attributes of crop canopies such as leaf area index, biomass and percent soil cover which may be related to grain yield.
- Determine the effects of stressed, normal, and above average growing conditions on the radiation patterns and spectral identification of corn, soybeans, and small grains. Stresses of particular interest are moisture deficits, nutrient deficiencies and diseases.
- Identify and quantify the agronomic, environmental and measurement conditions which are the dominant factors determining observed spectral characteristics.
- Determine the effects of soil background conditions such as color, texture, roughness and moisture on the spectral response of crop canopies.



- Compare and evaluate the capability of present, planned and possible future sensors to capture available spectrally derived information describing crops and soils.

## 1.2 Experimental Approach

During 1979, experiments emphasizing corn and soybeans, together with wheat and other small grains will be conducted. Although it would be highly desirable to initiate work on other crops such as rice, sorghum, and cotton, resources to do so are not available in 1979.

An overview of the experimental approach is shown in Figure A-1. At the beginning of the project the technical issues and specific objectives to be addressed with field research data were defined. This led to the definition of the experimental design for data acquisition and processing and the initial definition of data analysis plans and products.

A multistage approach to data acquisition with areal, vertical, and temporal staging is used (Figure A-2). Areal sampling is accomplished with test sites in different parts of the Great Plains and Corn Belt. Vertical staging, or collection of data by different sensor systems at different altitudes, ranges from mobile towers to Landsat. Temporally, data is collected at seven to 21-day intervals to sample important crop growth stages, and during several years to obtain a measure of the year-to-year variations in growing conditions and their influence on spectral response.

The test locations are two-five by six mile segments in Hand County, South Dakota, and Webster County, Iowa, and two agricultural experiment stations the Purdue University Agronomy Farm at West Lafayette, Indiana, and the University of Nebraska, Sandhills Agricultural Laboratory near North Platte, Nebraska (Figure A-3). Winter wheat and spring wheat are both major crops in Hand County, while the other sites were selected for study of corn and soybeans.

Table A-1. Outline of Supporting Field Research project plan.

- 
- I. Introduction
  - II. Objectives and Summary of Experimental Approach
  - III. Test Site Descriptions
    - A. Webster County, Iowa
    - B. Hand County, South Dakota
  - IV. Descriptions of Controlled Experiments
    - A. Purdue Agronomy Farm
    - B. Sandhills Experiment Station
  - V. Description of Data Analysis and Modeling
    - A. Crop Growth and Development Stage Determination
    - B. Estimation of Canopy Variables
    - C. Effects of Stress
    - D. Effects of Agronomic, Environmental and Measurement Conditions
    - E. Effects of Soil Background Conditions
    - F. Comparison of Sensor Capabilities
  - VI. Data Acquisition
    - A. Field Research Test Sites
    - B. Purdue Agronomy Farm
    - C. Sandhills Experiment Station
  - VII. Sensor Descriptions
    - A. Landsat Multispectral Scanner
    - B. Airborne Multispectral Scanners
    - C. Helicopter-borne Field Spectrometer System
    - D. Truck-mounted Field Spectrometer Systems
  - VIII. Sensor Calibration and Correlation Procedures
    - A. Calibration of Truck-mounted Spectrometer Systems
    - B. Calibration of Helicopter-borne Field Spectrometer System
    - C. Calibration of Airborne Multispectral Scanner Data
    - D. Sensor Correlation Procedures
  - IX. Data Processing
    - A. Landsat Multispectral Scanner Data
    - B. Aircraft Multispectral Scanner Data
    - C. Field Spectrometer System (FSS) Data
    - D. Exotech Model 20C Spectroradiometer Data
  - X. Data Evaluation and Verification
    - A. Landsat MSS Data
    - B. Aircraft Multispectral Scanner and Photographic Data
    - C. Helicopter and Truck-mounted Spectrometer Data
  - XI. Data Library and Data Distribution
  - XII. Schedules
  - XIII. Project Organization and Management
  - XIV. References
-

The primary sensors for data collection are truck-mounted radiometer and spectrometer, a helicopter-borne spectrometer, and aircraft multi-spectral scanner, and the Landsat-2 and -3 multispectral scanners. Each sensor system has unique capabilities for acquiring spectral data. The spectrometer systems produce the highest quality reflectance measurements, but provide only limited measurements of spatial variability. On the other hand, an aircraft scanner provides spatial sampling of the scene and can obtain data at multiple altitudes, but its spectral coverage, while broader than Landsat MSS, is limited to a fixed set of wavelength bands. The helicopter and aircraft data acquisition systems have the advantage of flexible scheduling and, therefore, provide greater opportunity to obtain cloud-free data at critical crop growth stages than the Landsat system provides. Landsat provides wide-area coverage, but is limited in its spatial resolution and the placement and number of spectral bands.

The staging of data acquisition is summarized in Figure A-2. Helicopter-spectrometer and aircraft-scanner data is collected over commercial fields in a series of flightlines over the sites in Hand and Webster counties. Landsat MSS data is also acquired and processed for each Landsat overpass during the seasons over the entire test site. These data provide a measure of the natural variation in the temporal-spectral characteristics of wheat, corn, and soybeans and surrounding cover types.

The truck-mounted spectrometer and radiometer collect spectra of crops in controlled experimental plots of corn, soybeans, and winter wheat at the Purdue Agronomy Farm. These data combined with the more detailed and quantitative measurements of crop and soil conditions which can be made on the plots, enable more complete understanding and interpretation of the spectra collected from commercial fields. Past experience has shown that there are generally too many interacting variables in commercial fields to determine exact causes of observed differences in spectral response. With data from plots where only two to four factors are varied under controlled conditions, it is possible to determine more exactly and understand more fully the energy-matter interactions occurring in crops.

The spectral measurements are supported by descriptions of the targets and their condition. The observations, counts, and measurements of the crop canopy include: maturity stage, plant height, biomass, leaf area index, percent soil cover, and grain yield. Also, included are measurement conditions such as sensor altitude and view angle, as well as measurements of the atmospheric and meteorological conditions. The data are supplemented by aerial photography and ground-level vertical and oblique photographs of the fields and test plots.

A data library of all spectral, agronomic, meteorological and photographic data collected is maintained at Purdue/LARS. The data are processed in standard data formats and measurements units and are made available to NASA/JSC-supported investigators and other interested researchers upon request.

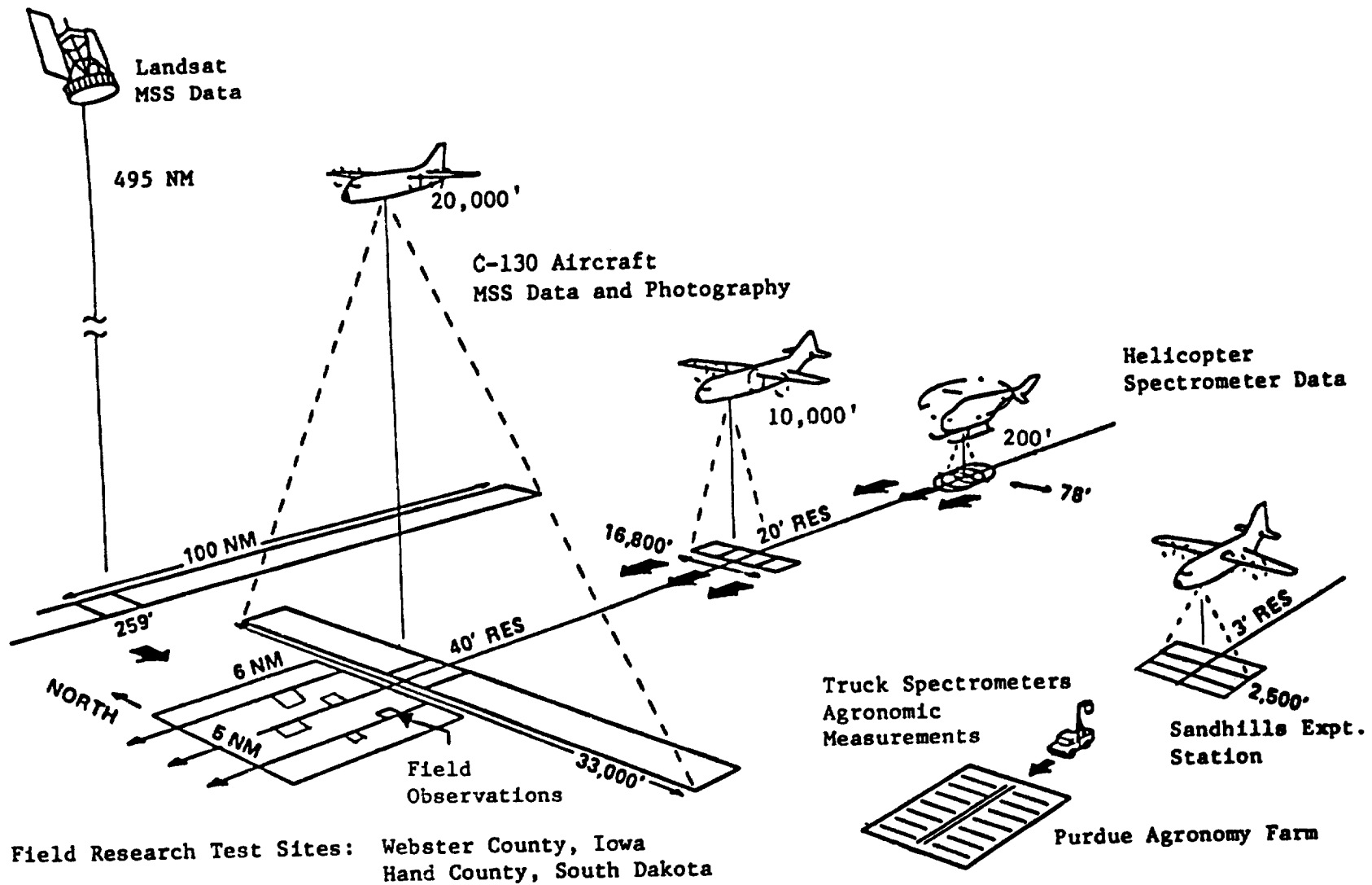

Figure A-2. Schematic illustration of multistage approach to multicrop field research data acquisition.

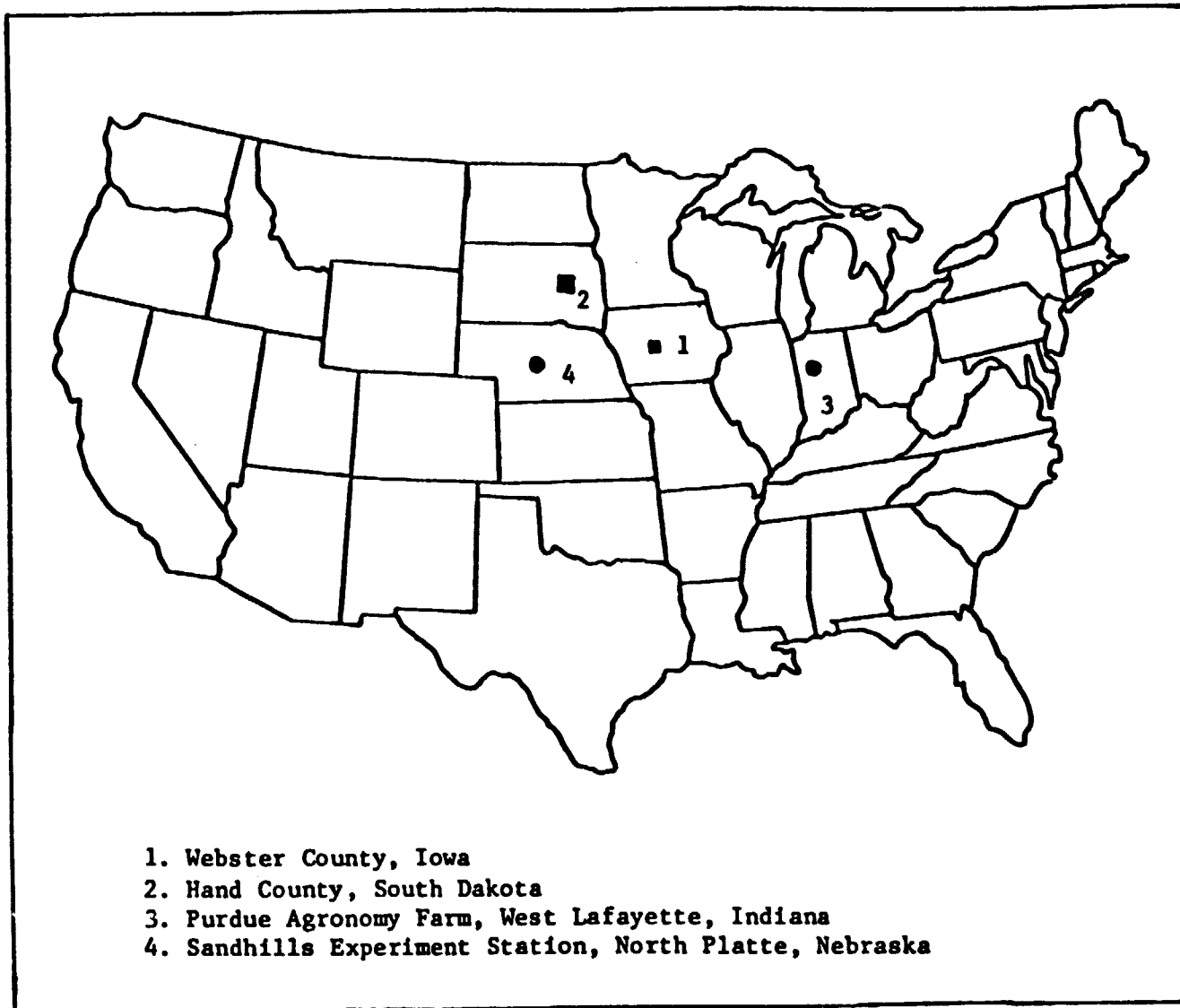

Figure A-3. Locations of 1979 Supporting Field Research test sites.

## 2. Data Analysis

In this section the results of several analyses of field research data conducted during the past year are briefly summarized. The past year has been in many ways a year of transition from analyses of LACIE Field Research data which looked at wheat and other small grains to AgRISTARS Supporting Field Research where considerable attention is being given (by Purdue) to acquisition and analysis of data on corn and soybeans.

During the past year two studies of wheat largely described in last year's final report have been completed and will be submitted to technical journals. In completing the work, our previous analyses of the relationships of crop canopy variables such as leaf area index were extended to evaluate prediction equations on independent data sets. The results provide additional evidence that measures of vegetative growth, including leaf area index, biomass, and percent cover can be predicted from multispectral measurements. In the second investigation, additional analyses of the source of variation in the spectral response of spring wheat canopies were completed. In this experiment, planting date and soil moisture were the primary factors which affected the reflectance of canopies from tillering to maturity. Differences in reflectance were primarily caused by differences in leaf area index, biomass, percent soil cover, and maturity stage. Additional analyses and modeling of the spectral response of spring wheat canopies as a function of maturity stage, solar zenith and azimuth angles, sensor view angle and direction, and wavelength are being conducted and will be reported at a later date.

Preliminary results from two investigations with corn and soybean data acquired in 1978 at the Purdue Agronomy Farm have been obtained and are briefly summarized in the following sections. Additional analyses of these data are currently being performed and collection of a second year's data on the same experiments has recently been completed.

### 2.1 Soybean Canopy Reflectance Characteristics

The objectives of the first experiment were to determine the

relationship of reflectance and agronomic characteristics of soybean canopies throughout the growing season, including (1) examination of the effects of cultural practices on reflectance and (2) prediction of canopy characteristics from reflectance measurements.

Reflectance spectra and agronomic measurements were acquired for 81 soybean plots throughout the 1978 growing season. The factors investigated were three row spacings (15, 46 and 91 cm), three plant populations (185, 259, and 334 thousand plants per hectare) and three cultivars (Amsoy, Wells and Elf). At intervals of 5 to 10 days, spectral reflectance was measured in four Landsat MSS wavelength bands using an Exotech 100 radiometer. Agronomic measurements included plant height, biomass, leaf area index, percent soil cover, maturity stage and surface soil moisture.

In analyzing the data it was found that plant population had no significant effect on reflectance, height, biomass, leaf area index or percent soil cover.

Figure A-4 shows the relationship of maturity stage (measurement date) to reflectance during the growing season. There were no significant differences among the three cultivars except near the end of the growing season when differences in maturity stage caused significant changes in reflectance. Row width caused differences in both red and infrared reflectance until the wide rows reached approximately 100 percent soil cover (Figure A-5).

High correlations were found between reflectance in both red and near infrared wavelength bands (Figures A-6) to percent soil cover. And, these relationships were used to develop a simple regression model to predict percent soil cover (Figure A-7). Similar analyses are being conducted for other canopy variables.

In summary, (1) no significant spectral or agronomic differences due to population were found, (2) the cultivars were spectrally and agronomically similar until near maturity, (3) row width which caused different proportions of soil and vegetation in the scene, was a dominant influence



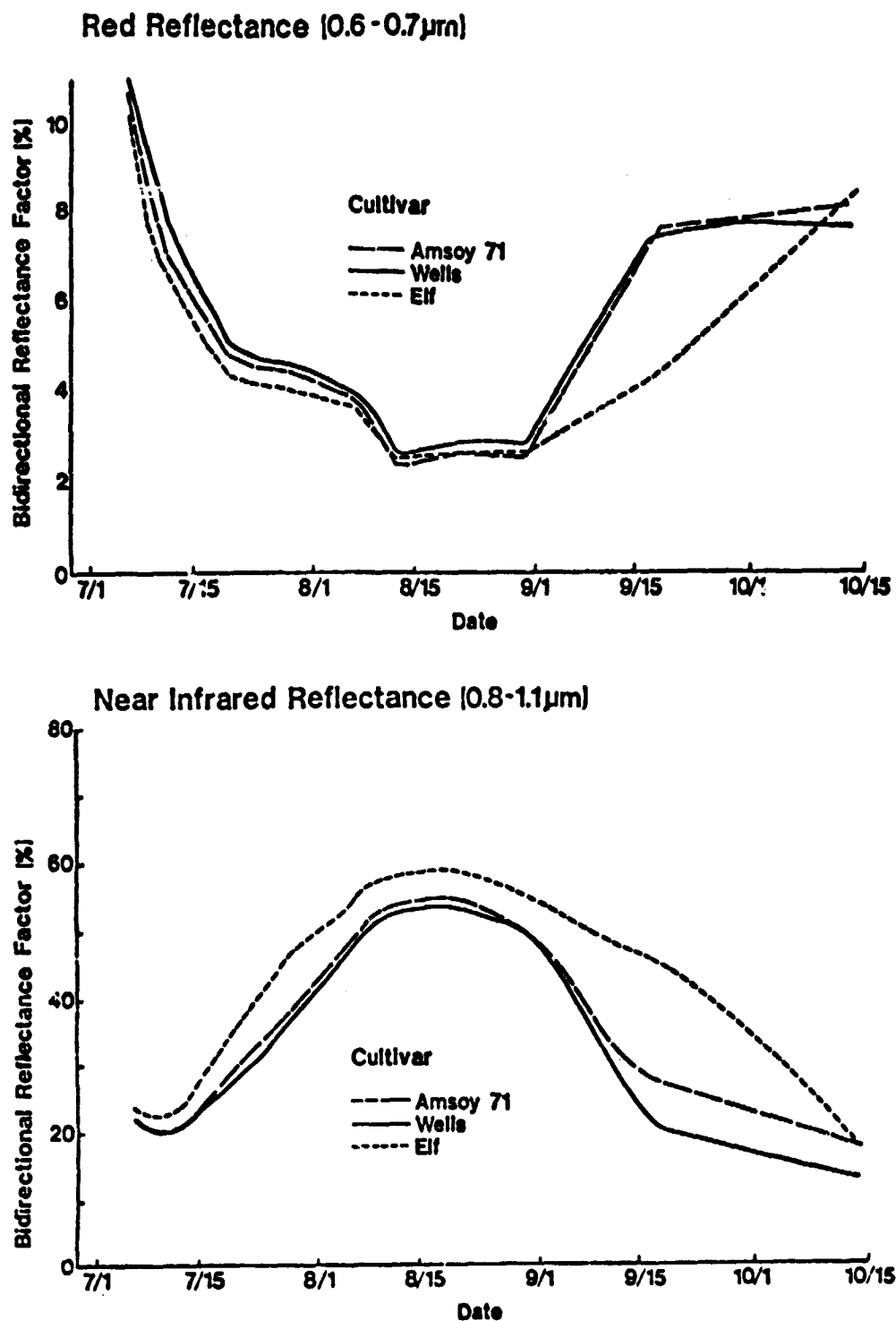

Figure A-4. Relationship of red and near infrared reflectance of three soybean cultivars canopy reflectance as a function of measurement date.

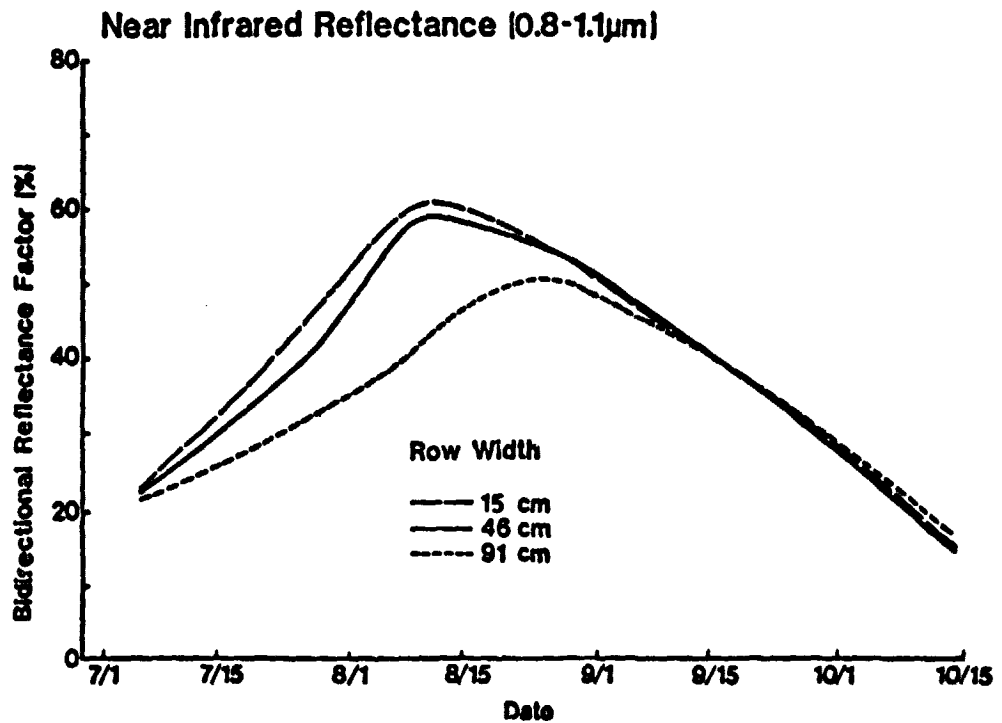
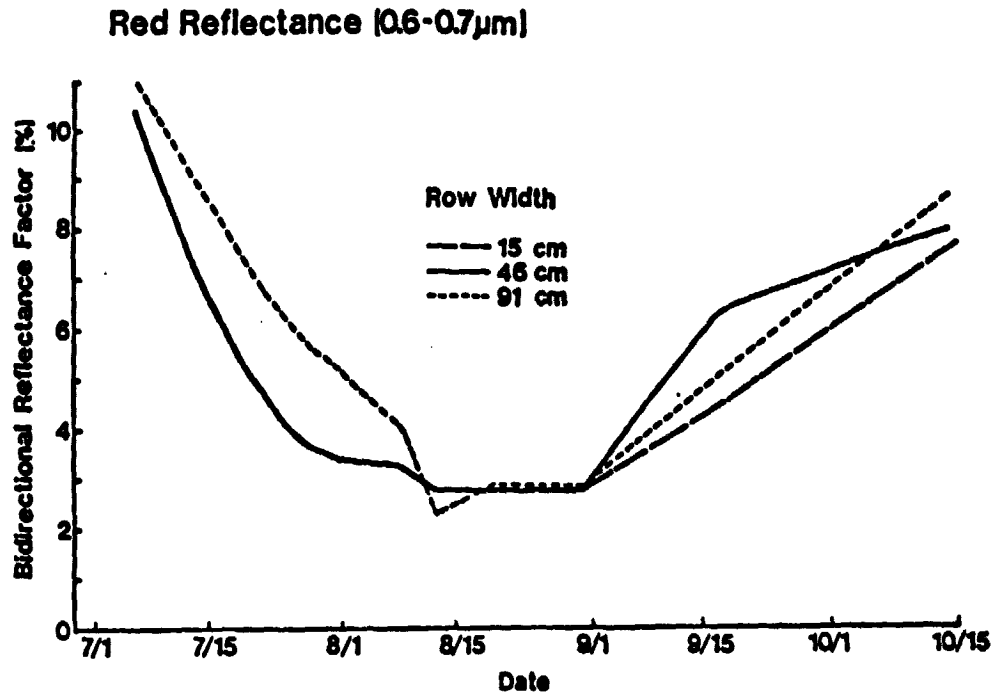

Figure A-5. Effect of row width on soybean canopy reflectance as a function of measurement date.

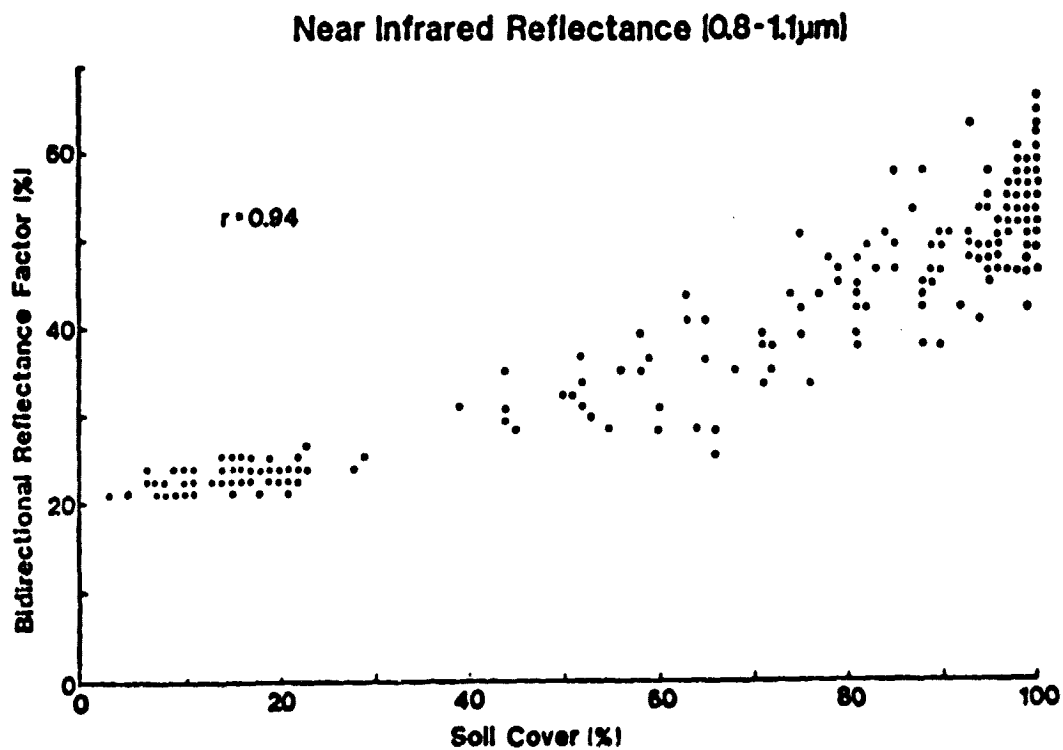
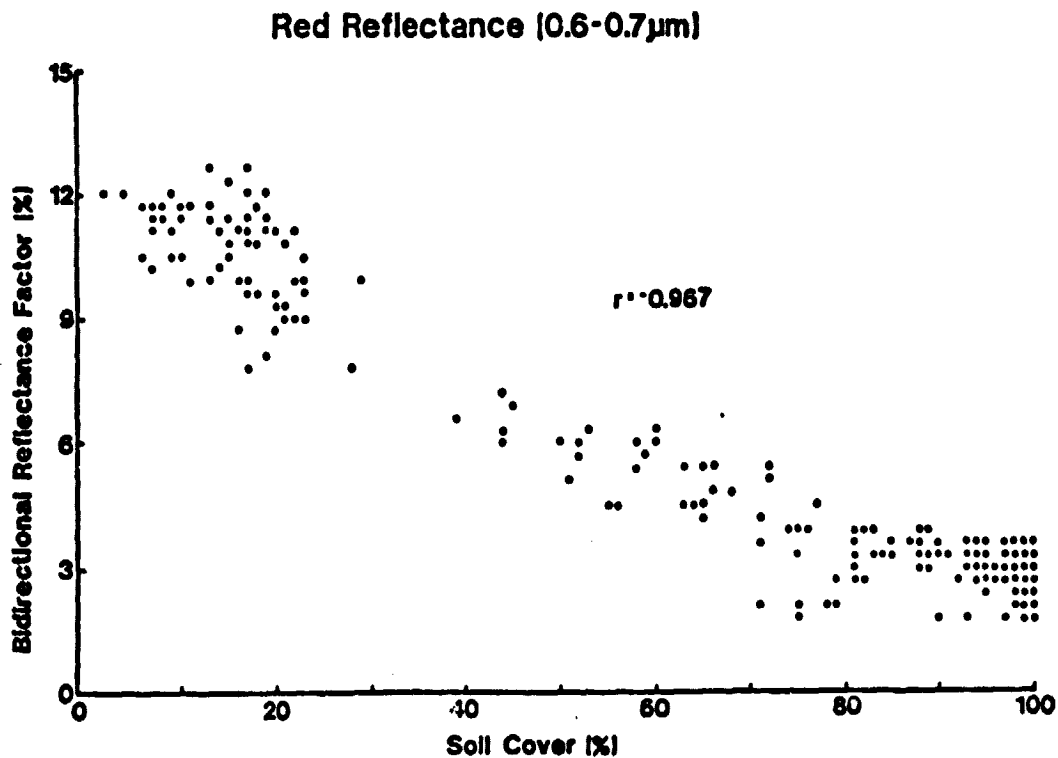

Figure A-6. Correlation of red and near infrared reflectance with percent soil cover of soybean canopies.

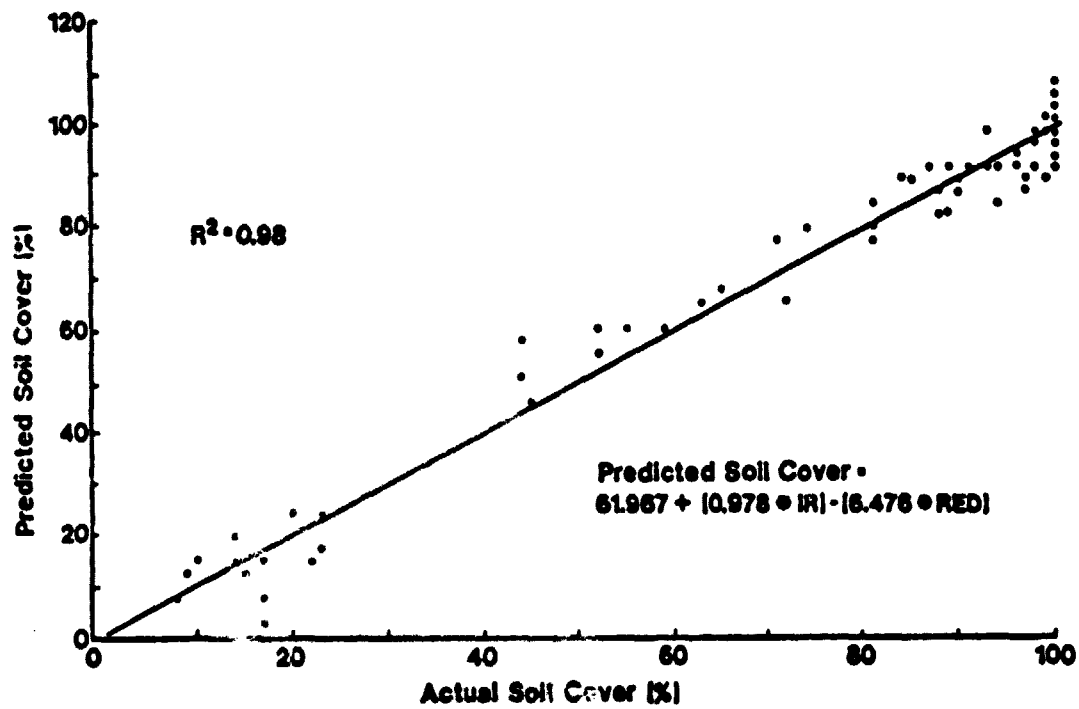

Figure A-7. Comparison of actual measurements of percent soil cover of soybean canopies with that predicted from reflectance measurements.

on reflectance throughout most of the season, (4) spectral reflectance was highly correlated with soil cover, and (5) prior to 100 percent soil cover, sun angle and row width interact to influence spectral reflectance.

## 2.2 Corn Canopy Reflectance Characteristics

In a second experiment, the relationship of the agronomic characteristics, particularly the effects of nitrogen fertilization, growth stage and leaf area and biomass to multispectral reflectance were investigated. Nitrogen deficiency has been shown to alter the single leaf reflectance characteristics of corn and other species, but few studies have been conducted with field-grown canopies.

In this experiment reflectance spectra and agronomic measurements were acquired throughout the growing season of 12 plots of corn. The experimental treatments were 0, 67, 134, and 202 kg per hectare of nitrogen fertilizer in a randomized complete block design with three replications. Bidirectional reflectance factor of the canopies was measured at approximately weekly intervals over the 0.4 to 2.4  $\mu\text{m}$  wavelength range using the Exotech 20C spectroradiometer. Agronomic measurements of the canopies included growth stage, leaf area index, percent soil cover, biomass, and nitrogen concentration.

The spectra for the low and high nitrogen fertilization treatments from a mid-August measurement date are shown in Figure A-8. The changes in soil cover, leaf area index, biomass, and plant nitrogen associated with measurement date (Maturity stage) and nitrogen fertilization level are shown in Figure A-9. In Figure A-10, the relationship of reflectance to measurement date and nitrogen fertilization are illustrated. And, in Figure A-11 the relationship of plant nitrogen content and leaf area index are shown.

In summary, nitrogen fertilization caused significant changes in several measures of the amount of vegetation, i.e. less nitrogen, less biomass, leaf area, and ground cover.

The agronomic characteristics of the canopies were in turn manifested in the spectral response of the canopies. Reflectances in the green and red wavelength regions were most strongly related to leaf and plant nitrogen concentrations. Leaf area index, biomass and percent soil cover were most strongly related to near infrared reflectance. The results indicate the potential of using multispectral remote sensing to monitor crop condition, but considerable more research is required to develop a complete and quantitative understanding of the effects of crop stresses, such as nitrogen deficiency, or the spectral response of crops.

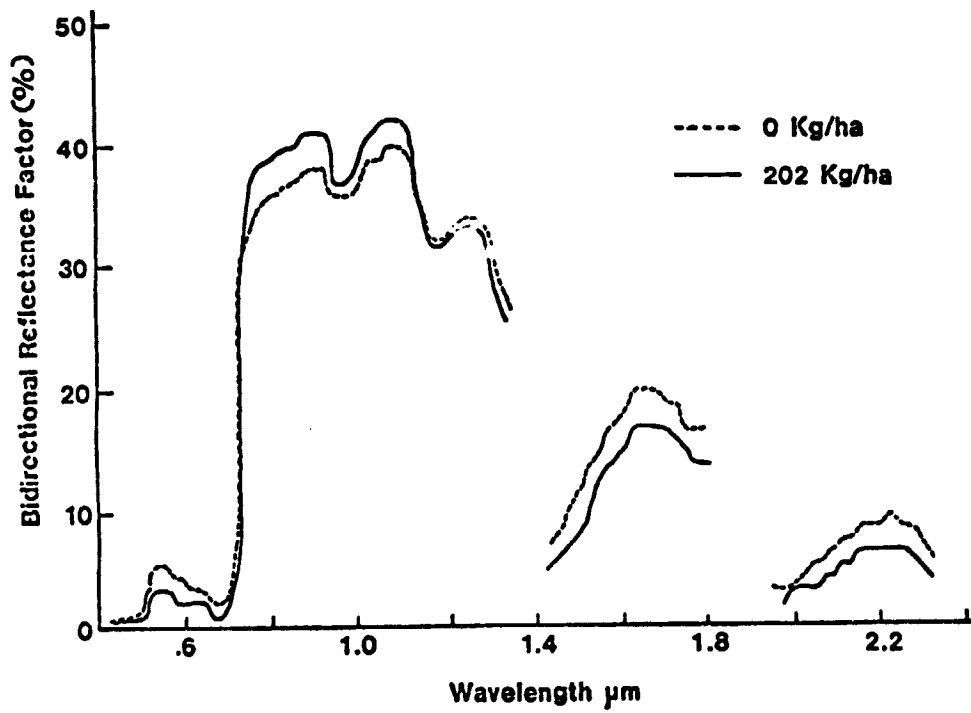

Figure A-8. Effect of nitrogen fertilization level on the spectral reflectance of corn canopies.

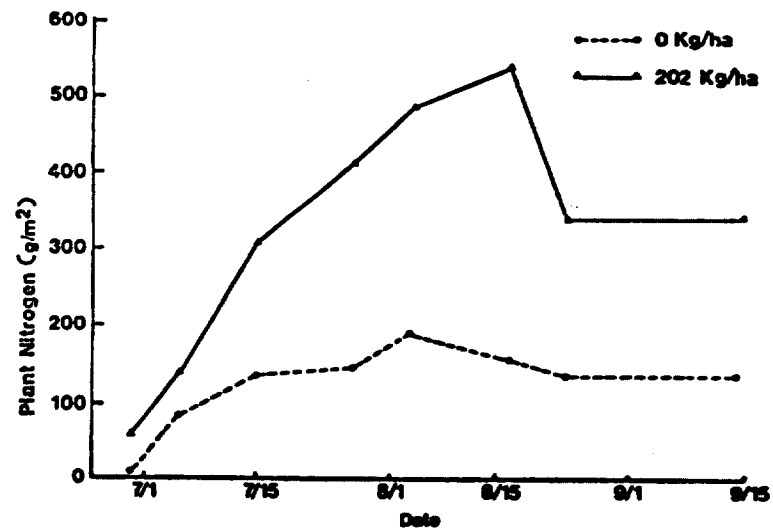
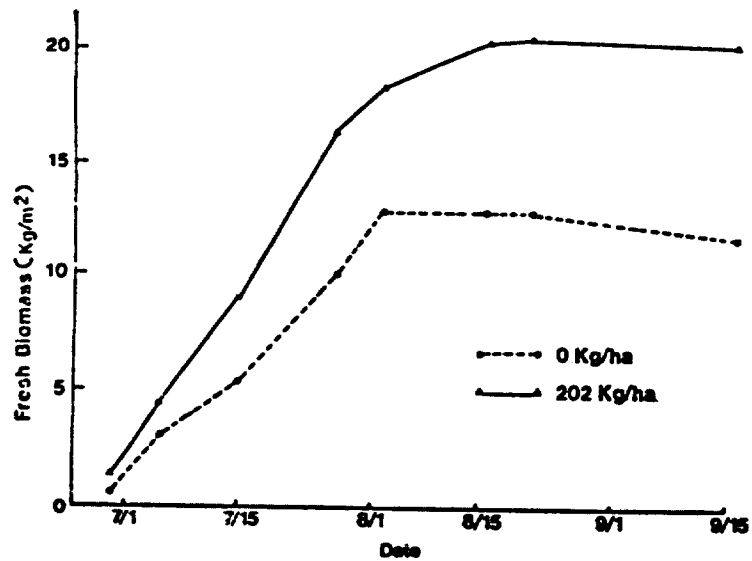
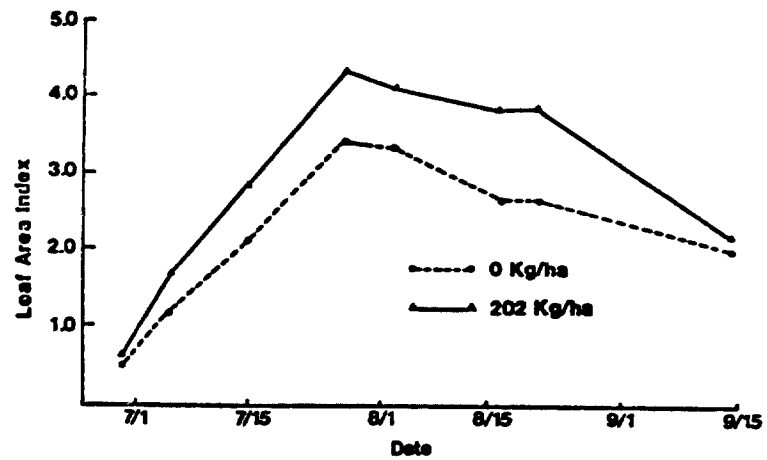
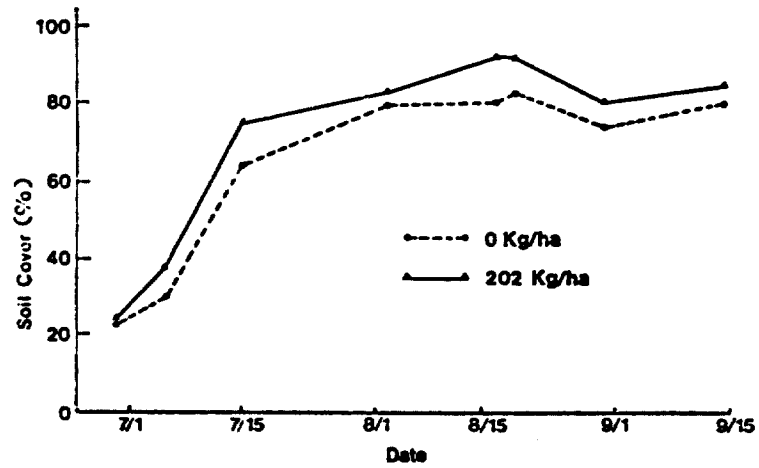

Figure A-9. Effect of nitrogen fertilization on percent soil cover, leaf area index, fresh biomass and plant nitrogen content of corn canopies as a function of measurement date.



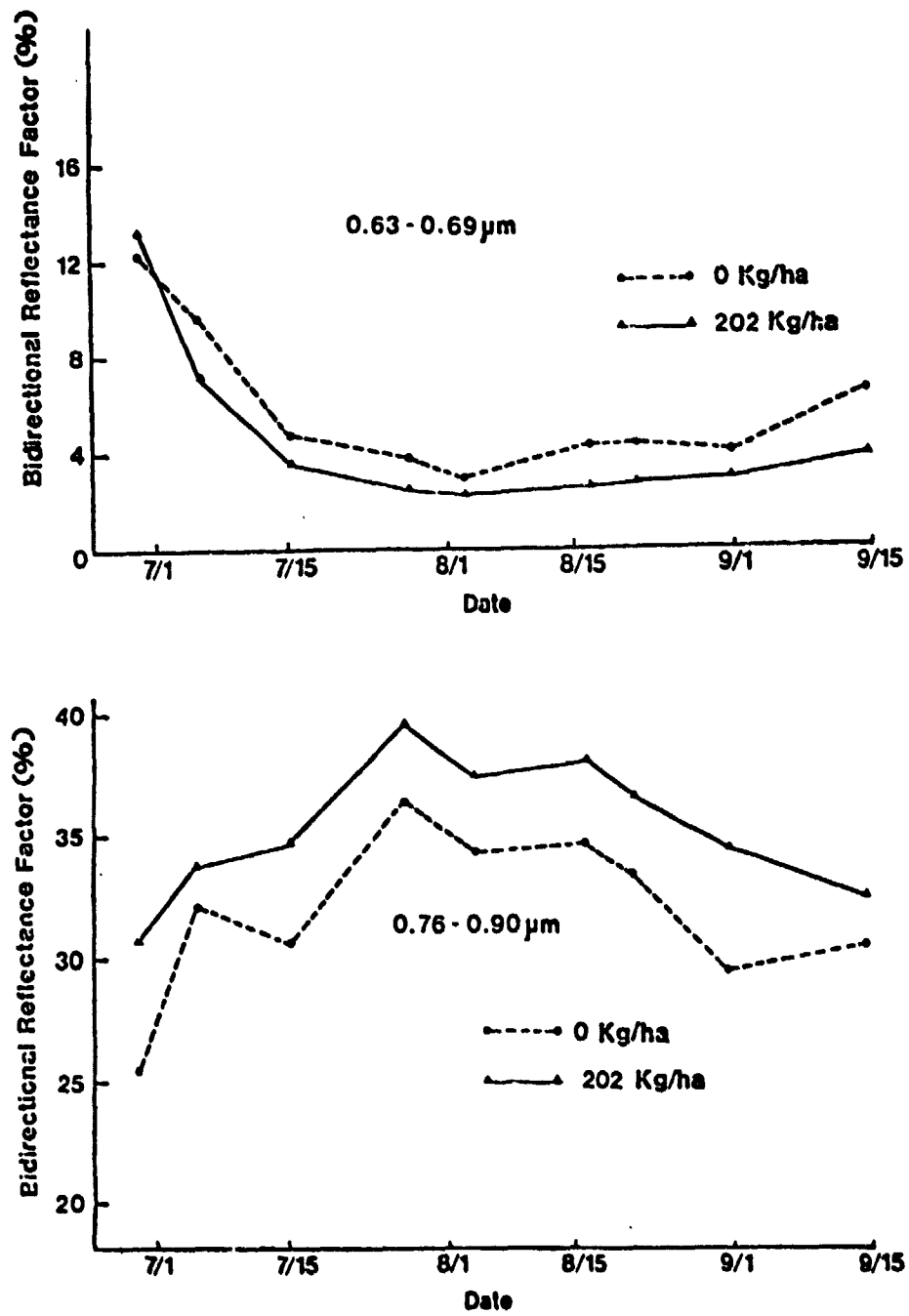

Figure A-10. Effect of nitrogen fertilization on the red and near infrared reflectance of corn canopies as a function of measurement date.

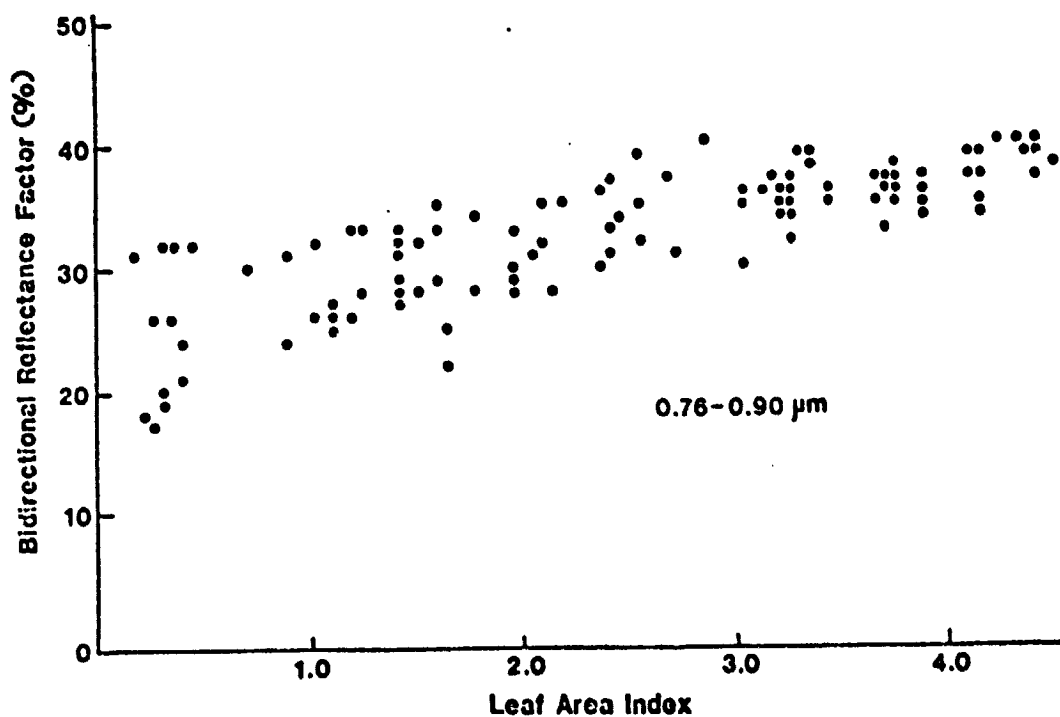
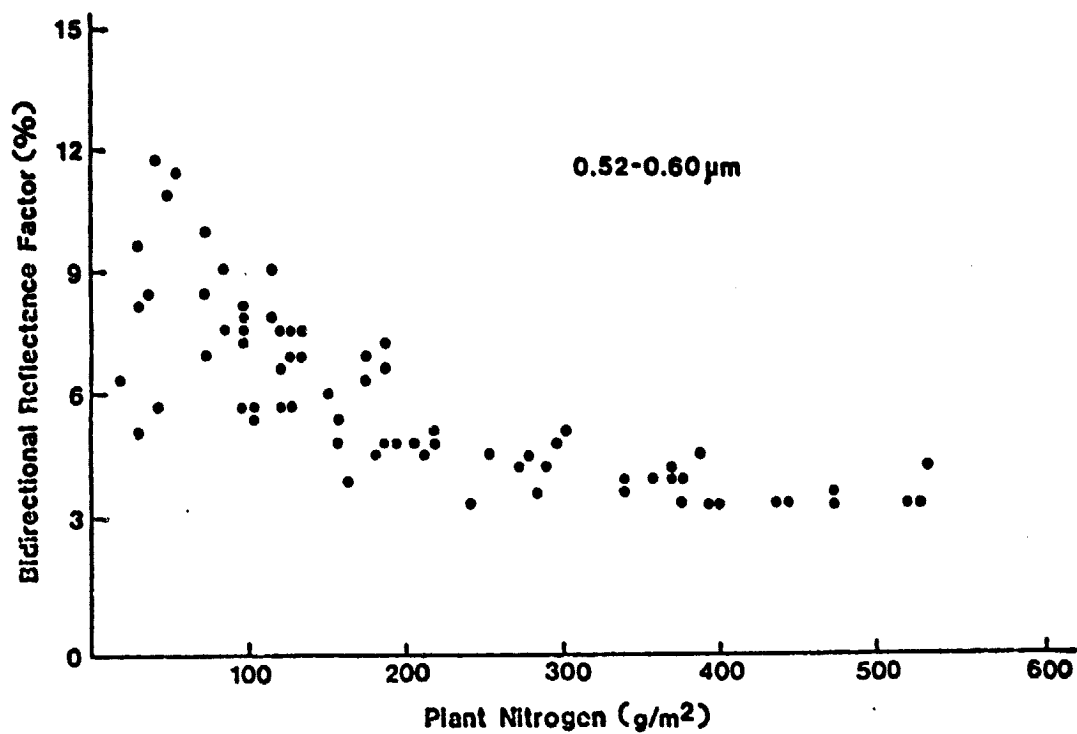

Figure A-11. Relationship of plant nitrogen and leaf area index to reflectance of corn canopies.

## B. FIELD RESEARCH DATA ACQUISITION AND PREPROCESSING\*

Larry L. Biehl and Craig S.T. Daughtry

The objectives of the task were to acquire and preprocess the data required to accomplish the objectives of the Supporting Field Research project as described in section A. The overall objectives of the task are: (1) develop data acquisition and preprocessing plans, (2) acquire the 1979 field research data as defined in the plans, and (3) preprocess the field research data for use by researchers. The data were acquired at the Purdue University Agronomy Farm and at test sites in Webster County, Iowa, Hand County, South Dakota, and MacPherson County, Nebraska.

### 1. Purdue Agronomy Farm Experiments

During 1978 experiments to investigate the spectral characteristics of corn and soybean crops were initiated at the Purdue Agronomy Farm. These experiments emphasized determination of the effects on the spectral responses of maturity stage, canopy variables such as leaf area index and biomass, stresses such as moisture and nutrient deficiencies, and cultural practices such as row spacing. These experiments, with some modification, and additions were continued to obtain additional years of data (1978 was an unusually good year with respect to weather although planting was late).

---

\*This section describing the results of work conducted under Task 1B, Field Research Data Acquisition and Preprocessing. The experiment design was led by Marvin Bauer and Craig Daughtry. The plot preparation and field measurements of wheat, corn, and soybeans were directed by Craig Daughtry. Barrett Robinson and Larry Biehl were responsible for the spectral measurements.

Greg Walburg, Jeff Kollenkark, Larry Hinzman, Vic Pollara, Mike Stabenfeldt, Joe Tarantino, Mark Lewis, Steve Jackson, E.B. Rawles, Karen Ortman, and Vic Fletcher assisted in the plot preparation and data collection. Cathy Kozlowski assisted by Don McLaughlin, Andy Teetzal, Mike Guba, Mike Sepp, and Cathy Axtell were responsible for the data processing.

### 1.1 Objectives

The following overall objectives were selected for the experiments to be conducted at the Purdue Agronomy Farm:

- To determine the reflectance and radiant temperature characteristics of corn and soybeans as a function of maturity stage and amount of vegetation present.
- To determine the effects of stresses including moisture deficits, nutrient deficiencies and disease on the reflectance and radiant temperature properties of corn, soybeans, and winter wheat.
- To determine the effect of important agronomic practices (e.g., planting date, plant population, fertilization) and environmental factors on the spectral characteristics of corn and soybeans.
- To support the development of corn and soybean yield models which use as an input spectral response as a function of crop development stage under stressed and normal growing conditions.
- To assess, using present and future Landsat spectral bands, the spectral separability of corn, soybeans, and other typical Corn Belt crops and cover types as a function of date and maturity stage and soil background conditions (color, texture, moisture, tillage).
- To determine the effects of measurements conditions such as sensor altitude and solar elevation and azimuth angles on crop reflectance.

### 1.2 Experiment Descriptions

Ten experiments were developed for the Purdue Agronomy Farm to accomplish the objectives of Supporting Field Research. The experiments included studies of crop stress, cultural practices, instrument observation parameters and canopy geometric characteristics. A summary of the experiments, treatments, and spectral instrument systems are given in Table B-1. More detailed descriptions of the experiment designs and treatments of the major experiments are given in Figures B-1 through B-5. The spectral and agronomic measurements were collected at approximately weekly intervals throughout the growing season.

#### Corn Cultural Practices Experiment

The objectives of this experiment are to determine (1) the threshold

Table B-1. Summary of the 1979 Supporting Field Research Experiments at the Purdue Agronomy Farm.

---

Experiment, Treatments, and Primary Sensor System

---

Winter Wheat: Nitrogen Fertilization and Disease (Exotech 20C and Exotech 100)

- 3 Cultivars
- 3 Nitrogen Fertilizer Rates (0, 60, and 120 kg/ha)

Corn: Cultural Practices (Exotech 100)

- 3 Planting Dates (May 2, 16, and 30)
- 3 Plant Populations (25, 50, and 75 thousand plants/ha)
- 2 Soil Types (Chalmers-dark and Fincastle-light)
- 2 Replications

Soybeans: Cultural Practices (Exotech 100)

- 3 Planting Dates (May 10, 24, and June 7)
- 2 Cultivars (Amsoy-narrow, group II maturity and Williams-bushy, group III maturity)
- 2 Soil Types (Chalmers-dark and Fincastle-light)
- 2 Replications

Corn: Nitrogen Fertilization (Exotech 20C)

- 4 Nitrogen Fertilizer Rates (0, 67, 134, 202 kg/ha)
- 3 Replications

Corn: Disease Southern Corn Leaf Blight(Exotech 20C)

- 3 Leaf Blight Treatments (None-resistant, early and late infection)
- 2 Hybrids (Pioneer 3545 and DeKalb XL43)
- 2 Replications

Corn and Soybeans: Moisture Stress (Exotech 20C)

- 3 Moisture Levels

Corn: Soil Background (Exotech 100)

- 2 Surface Moisture Levels (moist and dry)
- 2 Surface Tillage Conditions (rough and smooth)
- 2 Replications

Soybeans: Row Direction and Solar Azimuth and Zenith Angles (Exotech 100)

- 9 Row Directions(90,105,120,135,150,165,180,210,240 degrees planted in 76 cm rows, plus narrow rows (25 cm) and bare soil)

Table B-1. Con't

---

Experiments, Treatments and Primary Sensor System

---

Soybeans and Corn: Sensor Altitude and Field of View (Exotech 100)

10 Sensor Heights from 0.5 to 10 m above canopy

Wheat, Corn and Soybeans: Geometric Characterization

2 Crops (corn and soybeans)

3 Methods (laser, point quadrat and photographic)

---

Light Soil (Fincastle silt loam)

Dark Soil (Chalmers silty clay loam)



Plot No.	65	64	63	62	61	60	59	58	57	56
Treatment Code	D <sub>1</sub> P <sub>3</sub>	D <sub>3</sub> P <sub>2</sub>	D <sub>2</sub> P <sub>1</sub>	Bare	D <sub>3</sub> P <sub>1</sub>	D <sub>2</sub> P <sub>3</sub>	D <sub>1</sub> P <sub>1</sub>	D <sub>3</sub> P <sub>3</sub>	D <sub>2</sub> P <sub>2</sub>	D <sub>1</sub> P <sub>2</sub>
Plot No.	66	67	68	69	70	71	72	73	74	75
Treatment Code	D <sub>1</sub> P <sub>1</sub>	D <sub>3</sub> P <sub>2</sub>	D <sub>2</sub> P <sub>1</sub>	D <sub>1</sub> P <sub>2</sub>	D <sub>3</sub> P <sub>3</sub>	D <sub>2</sub> P <sub>2</sub>	Bare	D <sub>3</sub> P <sub>1</sub>	D <sub>2</sub> P <sub>3</sub>	D <sub>1</sub> P <sub>3</sub>

Plot No.	50	49	48	47	46	45	44	43	42	41
Treatment Code	D <sub>3</sub> P <sub>3</sub>	D <sub>2</sub> P <sub>3</sub>	D <sub>1</sub> P <sub>1</sub>	D <sub>1</sub> P <sub>2</sub>	D <sub>3</sub> P <sub>2</sub>	Bare	D <sub>1</sub> P <sub>3</sub>	D <sub>2</sub> P <sub>1</sub>	D <sub>3</sub> P <sub>1</sub>	D <sub>2</sub> P <sub>2</sub>
Plot No.	81	82	83	84	85	86	87	88	89	90
Treatment Code	D <sub>3</sub> P <sub>2</sub>	D <sub>2</sub> P <sub>2</sub>	D <sub>1</sub> P <sub>3</sub>	Bare	D <sub>3</sub> P <sub>3</sub>	D <sub>1</sub> P <sub>1</sub>	D <sub>1</sub> P <sub>2</sub>	D <sub>2</sub> P <sub>3</sub>	D <sub>3</sub> P <sub>1</sub>	D <sub>2</sub> P <sub>1</sub>

10 m

10 m

4.6 m

Treatment Descriptions

Notes

Planting Dates

Plant Populations

D<sub>1</sub>=May 2, 1979

P<sub>1</sub>=25,000 plants/ha

D<sub>2</sub>=May 16, 1979

P<sub>2</sub>=50,000 plants/ha

D<sub>3</sub>=May 30, 1979

P<sub>3</sub>=75,000 plants/ha

1. Hybrid: Beck 65X
2. Row width: 76 cm
3. Location: Purdue Agronomy Farm, Field 31-1B

Figure B-1. Design and treatment descriptions of the 1979 Purdue Agronomy Farm corn cultural practices experiment.

### Dark Soil

Plot No.	144	145	146	143	142	141	140	139	138	137	136	135	134	15 m
Treatment Code	D <sub>1</sub> R <sub>1</sub> V <sub>1</sub>	D <sub>3</sub> R <sub>2</sub> V <sub>2</sub>	D <sub>1</sub> R <sub>2</sub> V <sub>1</sub>	D <sub>2</sub> R <sub>2</sub> V <sub>1</sub>	D <sub>2</sub> R <sub>2</sub> V <sub>2</sub>	D <sub>2</sub> R <sub>1</sub> V <sub>1</sub>	D <sub>3</sub> R <sub>2</sub> V <sub>2</sub>	D <sub>1</sub> R <sub>1</sub> V <sub>1</sub>	D <sub>2</sub> R <sub>1</sub> V <sub>2</sub>	D <sub>3</sub> R <sub>1</sub> V <sub>1</sub>	D <sub>1</sub> R <sub>2</sub> V <sub>2</sub>	D <sub>3</sub> R <sub>1</sub> V <sub>2</sub>	Bare	

Plot No.	121	122	123	124	125	126	127	128	129	130	131	132	133	15 m
Treatment Code	D <sub>2</sub> R <sub>1</sub> V <sub>2</sub>	D <sub>1</sub> R <sub>1</sub> V <sub>2</sub>	D <sub>3</sub> R <sub>2</sub> V <sub>1</sub>	D <sub>3</sub> R <sub>2</sub> V <sub>2</sub>	D <sub>2</sub> R <sub>2</sub> V <sub>1</sub>	D <sub>1</sub> R <sub>2</sub> V <sub>2</sub>	D <sub>2</sub> R <sub>1</sub> V <sub>1</sub>	D <sub>1</sub> R <sub>2</sub> V <sub>1</sub>	D <sub>1</sub> R <sub>1</sub> V <sub>1</sub>	D <sub>3</sub> R <sub>1</sub> V <sub>2</sub>	D <sub>2</sub> R <sub>2</sub> V <sub>2</sub>	D <sub>3</sub> R <sub>1</sub> V <sub>1</sub>	Bare	4 m

### Light Soil

Plot No.	161	162	163	164	165	166	167	168	169	170	171	172	173	15 m
Treatment Code	D <sub>2</sub> R <sub>1</sub> V <sub>1</sub>	D <sub>3</sub> R <sub>2</sub> V <sub>1</sub>	D <sub>1</sub> R <sub>2</sub> V <sub>1</sub>	D <sub>3</sub> R <sub>2</sub> V <sub>2</sub>	D <sub>2</sub> R <sub>2</sub> V <sub>1</sub>	D <sub>2</sub> R <sub>1</sub> V <sub>2</sub>	Bare	D <sub>1</sub> R <sub>1</sub> V <sub>2</sub>	D <sub>1</sub> R <sub>2</sub> V <sub>2</sub>	D <sub>1</sub> R <sub>1</sub> V <sub>1</sub>	D <sub>3</sub> R <sub>1</sub> V <sub>1</sub>	D <sub>2</sub> R <sub>2</sub> V <sub>2</sub>	D <sub>3</sub> R <sub>1</sub> V <sub>2</sub>	

Plot No.	174	175	176	177	178	179	180	181	182	183	184	185	186	15 m
Treatment Code	D <sub>2</sub> R <sub>2</sub> V <sub>2</sub>	D <sub>1</sub> R <sub>2</sub> V <sub>2</sub>	D <sub>3</sub> R <sub>2</sub> V <sub>1</sub>	D <sub>2</sub> R <sub>1</sub> V <sub>1</sub>	D <sub>2</sub> R <sub>1</sub> V <sub>2</sub>	D <sub>3</sub> R <sub>1</sub> V <sub>2</sub>	D <sub>1</sub> R <sub>2</sub> V <sub>1</sub>	D <sub>2</sub> R <sub>2</sub> V <sub>1</sub>	D <sub>3</sub> R <sub>1</sub> V <sub>1</sub>	Bare	D <sub>3</sub> R <sub>3</sub> V <sub>2</sub>	D <sub>1</sub> R <sub>1</sub> V <sub>1</sub>	D <sub>1</sub> R <sub>1</sub> V <sub>2</sub>	3.8 m

### Treatment Descriptions

#### Planting Date

<u>Dark Soil</u>	<u>Light Soil</u>	<u>Row Width</u>	<u>Variety</u>
D <sub>1</sub> = May 10	D = May 24	R = 25 cm	V = Amsoy 71
D <sub>2</sub> = May 24	D <sub>1</sub> = June 15	R <sub>1</sub> = 76 cm	V <sub>1</sub> = Williams
D <sub>3</sub> = June 15	D <sub>2</sub> = July 3		

Figure B-2. Design and treatment descriptions of the 1979 Purdue Agronomy Farm soybean cultural practices experiment.



of early season spectral detection of corn, (2) the spectral response of corn as a function of growth and amount of vegetation, and (3) the effect soil background differences, particularly soil color, on the spectral response and early detection of corn. The treatments were as follows:

- 3 Planting Dates ( May 2, 16, and 30)
- 3 Plant Populations (25,000, 50,000 and 75,000 plants per hectare)
- 2 Soil Types (Chalmers, dark and Fincastle, light)

A split plot design with two replications was used. Spectral measurements, along with agronomic characterizations of the canopies and surface soil, were made at approximately weekly intervals throughout the growing season.

The spectral reflectance measurements were made with a Landsat band radiometer (Exotech Model 100). Radiant temperatures and overhead color photographs of the canopies were obtained simultaneously with the reflectance measurements. The major agronomic measurements of the plots included growth stage, percent soil cover, height, leaf area index, biomass, and surface soil moisture and condition. Grain yields were measured at harvest time.

#### Soybean Cultural Practices Experiment

The objectives of this experiment are the same as the corn cultural practices experiment. Treatments similar to those of the corn experiment, but representing major different soybean cultural practices were selected. The treatments were as follows:

- 3 Planting Dates (May 10, May 24 and June 14)
- 2 Row Spacings (25 and 76 cm)
- 2 Cultivars (Amsoy, narrow canopy type and Williams, bushy type)
- 2 Soil Types (Chalmers and Fincastle)

A split plot design with two replications was used. Spectral and agronomic measurements were made as for the corn experiment.

#### Corn Stress Experiments

Experiments with three major types of stress were conducted on corn:

nitrogen nutrition, southern corn leaf blight disease, and moisture deficits. These stresses were selected as examples of important factors influencing the growth and yield of corn. Nitrogen fertilization is one of the primary factors responsible for the increased yields in the U.S. in the past 25 years. Southern corn leaf blight is an example of a non-systemic fungus disease capable of significantly reducing the photosynthesis capacity of corn. And, differences in moisture availability account for much of the variation from year to year in corn yields.

#### Nitrogen Fertilization

The first experiment was with nitrogen fertilization. Four levels of fertilization, 0, 67, 134, and 202 kg/hectare, providing a range from distinctly deficient to abundant have been selected from a long term fertilization experiment. The specific objectives of the experiment were to (1) determine the threshold of spectral detection of nitrogen deficiency and (2) determine kind and magnitude of changes in reflectance and thermal response as a function of level of nitrogen nutrition. Three replications were used. Measurements were made at approximately 10 day intervals throughout the growing season with the Exotech 20C spectroradiometer over the 0.4 to 2.4  $\mu\text{m}$  wavelength range. Radiant temperature of the canopy was also measured. In addition to the standard agronomic data (leaf area index, etc.) leaf nitrogen and chlorophyll concentrations will be determined. And, leaf reflectance measurements were made on several dates.

#### Leaf Blight

The second experiment was to investigate the effects of a non-systemic fungus disease, southern corn leaf blight (*Helminthosporium maydis*), on the multispectral reflectance and radiant temperature of corn. The specific objectives of the experiment were similar to those of nitrogen fertilization experiment, i.e. determine the relationship of disease severity level to the spectral characteristics of corn. The factorial treatments included 2 Hybrids and 3 Leaf Blight Treatments (non, early and late inoculation). The early and late inoculation provided two different levels of disease

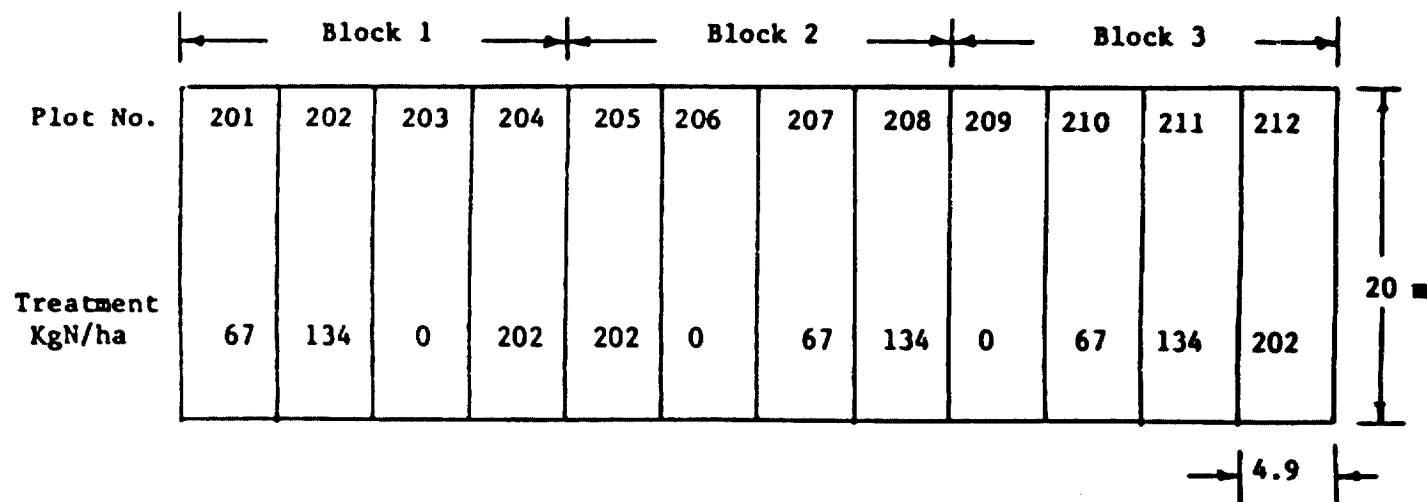

Notes

1. Pioneer 3183 corn was planted on May 10, 1979 at 66,100 plants/ha.
2. Six 71 cm-wide rows per plot. Row direction was East-west.
3. Purdue Agronomy Farm Field 55.

Figure B-3. Design and treatment descriptions of the 1979 Purdue Agronomy Farm corn nitrogen fertilization experiment.

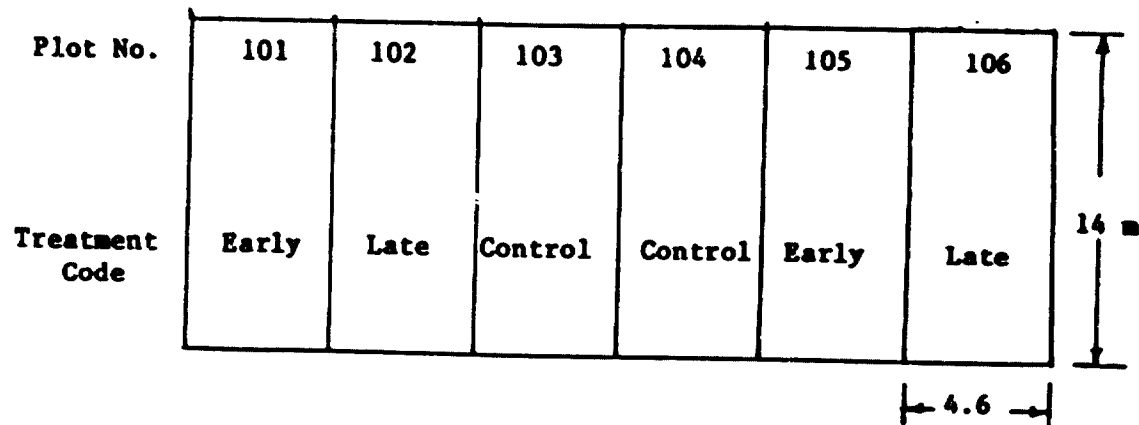

Notes

1. DeKalb XL43 planted on May 16, 1979 at 50,000 plants/ha .
2. Six 76 cm-wide rows per plot.
3. Purdue Agronomy Farm Field 10C (north side).
4. Early inoculation on July 10, 1979. Late inoculation on July 18, 1979.



Figure B-4. Design and treatment descriptions of the 1979 Purdue Agronomy Farm corn disease experiment.

severity at any given measurement date. The experiment was conducted using a randomized complete block design with two replications. After the disease became established (about July 1) measurements of reflectance and radiant temperatures were to be made with the Exotech 20C and PRT-5 sensors at weekly intervals until maturity. In addition to the standard agronomic characterization of the canopy the degree of infection (loss of green leaf area) was measured. Inclement weather in August and loss of one of the hybrids due to poor germination severely limited data collection on this experiment.

#### Moisture Stress

The third corn stress experiment was a limited study of the effects of deficits in plant available moisture on the spectral characteristics of corn canopies. Three levels of stress were to be established when the corn reached approximately one meter height: one, moderate, and severe. The corn was grown on sand beds, unlain by perforated pipe for rapid drainage. Varying amounts of water can be applied to the plots to provide different levels of available moisture. Spectral measurements were to be made with the Exotech 20C and PRT-5 systems at weekly intervals, along with the standard agronomic and meteorological measurements. However, due to an unexpected nutritional problem associated with use of a new sand, only a limited number of measurements were made of this experiment.

#### Winter Wheat Disease and Nitrogen Fertilization Experiment

In addition to the corn and soybean experiments, an experiment to investigate the effects of disease and nitrogen fertilization on the spectral and agronomic characteristics of winter was planted. There were three nitrogen fertilizer rates (0, 46, and 92 kg/hectare), and three disease treatments (resistant cultivar, susceptible cultivar, and susceptible treated with fungicide) with three replications in a randomized complete block design. Measurements of reflectance and radiant temperature of the wheat canopies were made with the Exotech 20C spectroradiometer system at approximately weekly intervals from tillering through ripe stages of

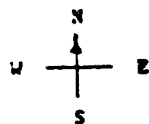
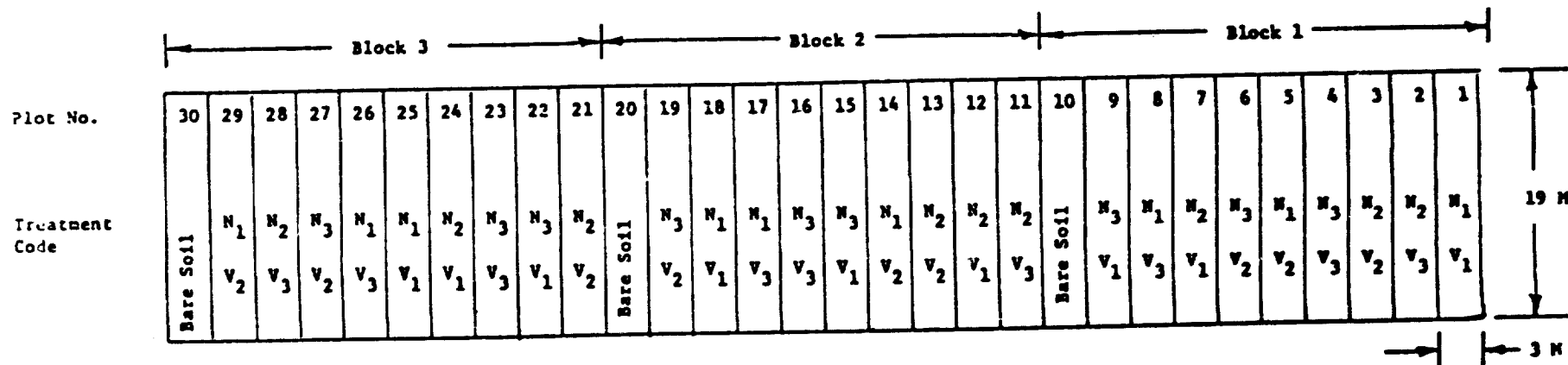

Nitrogen

N<sub>1</sub> - 0 Kg N/ha  
 N<sub>2</sub> - 60 Kg N/ha  
 N<sub>3</sub> - 120 Kg N/ha

Winter Wheat Variety

V<sub>1</sub> - Monon (susceptible, treated with fungicide)  
 V<sub>2</sub> - Monon (susceptible)  
 V<sub>3</sub> - Sullivan (resistant)

Planting date - October 5, 1978  
 Fertilizer - 32 Kg P/ha and 61 Kg K/ha

Figure B-5. Design and treatment descriptions of the 1979 Purdue Agronomy Farm Winter Wheat nitrogen fertilization and disease experiment.

development. Agronomic characterizations of the canopies included: leaf area index, biomass, percent soil cover, height, lodging, disease severity, leaf nitrogen concentration, and grain yield.

#### Row Direction and Solar Azimuth and Zenith Angles

The objective of the experiment is to determine the effect of rows and row direction, variables in the area of cultural practices, on the reflective response of a soybean canopy as a function of azimuth and zenith sun angles. The design of the experiment involved 11 plots. One plot was planted in east-west and north-south rows 25 cm wide to obtain, at later growth stages, a canopy with negligible row effects. A second plot was bare soil, providing an opportunity to monitor the reflectance of the soil background of the soybean plots. The remaining nine plots were planted in soybeans with 76 cm wide rows with the following azimuthal directions: 90-270, 105-285, 120-300, 135-315, 150-330, 165-345, 180-360, 210-030, and 240-060 degrees. The row directions were selected to maximize the probability of obtaining data during the morning hours when cloud conditions are more favorable for data collection than in the afternoon. Reflectance data were acquired at 15 minute intervals throughout the day on three days, representing three canopy growth stages. Data analysis will involve mathematically modeling the effect of combinations of sun azimuth and sun zenith angles on the reflectance from a row crop of soybeans. The experiment design permits the effect of sun angles to be analyzed independently.

#### Sensor Altitude and Field of View

The object of the experiment is to determine how the canopy reflectance varies as a function of height above the crop and, particularly, what minimum height is needed to acquire repeatable reflectance measurements. Data were acquired on three canopies, mature corn planted in 76 cm rows, mature soybeans planted in 96 cm rows with 50 to 70% ground cover, and mature soybeans planted in 76 cm rows with 100% ground cover. The canopies provided scenes with a range of row effects from pronounced rows to no obvious rows. Data were acquired at 10 heights ranging from 0.5m to 10m

above the canopy. At each height 12 reflectance data points were acquired at 15cm intervals in the direction perpendicular to the rows by moving the spectrometer along a horizontal board. The data analysis involves determining how the variance of the data obtained at each height changes with height. This analysis will provide the information necessary to place error bounds on reflectance data acquired at a particular height.

#### Comparison of Laser, Point Quadrat and Photographic Methods for Geometric Characterization

The objective of the experiment is to compare the reliability, applicability, and accuracy of three devices (laser, point quadrat, and photographs) to measure the geometric characteristics of a crop canopy. For comparison purposes wheat and corn canopies each were measured once and a soybean field was measured at three growth stages using the three devices. The analysis will involve performing a Students paired-T test on the data sets taken two at a time to determine if individual data sets are sampled from similar populations. In addition to the comparisons the data will be used to compute power and energy budgets for each of the crop canopies and to gain more understanding of the interaction of optical radiation with the components of the canopy.

#### 1.3 Data Acquisition

The spectral measurements of the experiments were made by either the Exotech 20C spectroradiometer system or the Exotech 100 radiometer system. Both systems also include Barnes PRT-5 sensors and 35 mm cameras, sighted to view the same area as the spectrometers. Spectral measurements also included vertical and oblique radiant temperatures with a Barnes PRT-5 instrument. The spectral measurements for the experiments are summarized in Table B-2. A special laboratory spectrometer was used in a pilot test to collect leaf reflectance measurements from the corn nitrogen experiment.

To obtain data which can be readily compared, the two instruments systems are operated following similar procedures. The instruments are operated from aerial towers at three to six meters above the target at



Table B-2. Summary of spectral measurements collected at the Purdue Agronomy Farm for the 1979 field research experiments.

---

Experiment, Instrument System, and Spectral Measurements

---

Stress Experiments (nutrition, moisture, disease)

Exotech 20C Field Spectrometer System

Bidirectional reflectance factor (0.4-2.4  $\mu\text{m}$ )  
Radiant temperature  
Color photographs

Cultural Practices Experiments (Corn, Soybeans)

Exotech 100 Field Radiometer System

Bidirectional reflectance factor (Landsat MSS spectral bands)  
Radiant temperature  
Color photographs

Instrument Parameter Experiments

Exotech 100 Field Radiometer System

Bidirectional reflectance factor (Landsat MSS spectral bands).  
Color photographs

---

heights which minimizes the shadowing of skylight and yet ensures that the field of view of the instrument includes only the desired subject. Care is taken to avoid scene shadowing and minimize the reflective interaction due to personnel or vehicles. The routine data taking mode of the instruments is straight down, for determination of bidirectional reflectance factor. Measurements of the BaSO<sub>4</sub> painted reference panel are made at 15 minute intervals. Two measurements of each plot are typically made by moving the sensor so that a new scene within the plot fills the field of view.

Data recorded at the time of each measurement describing the measurement parameters include: date, time, reference illumination, air temperature, barometric pressure, relative humidity, wind speed and direction, percent cloud cover and type, field of view, latitude, longitude, and zenith and azimuth view angles.

Detailed agronomic measurements of the crop canopies included crop development stage, vegetation measurements, crop condition, soil background condition, grain yield, and additional measurements for specific experiments. The agronomic measurements are summarized in Table B-3. The agronomic and spectral data are supplemented by vertical and horizontal color photographic of each plot.

Augmenting the spectral and agronomic measurements were meteorological data. The meteorological data included air temperature, barometric pressure, relative humidity, wind speed, and wind direction. A record of the irradiance was collected by a total incidence pyranometer on strip charts. Additional environmental data including precipitation, pan evaporation, dew point, solar radiation, and net radiation were acquired hourly by a computerized agricultural weather station located on the Agronomy Farm.

Spectral measurements, along with agronomic and meteorological data, were acquired on each day that weather conditions permitted. A general summary of the data collection by experiment for the Exotech 20C and

Table B-3. Summary of agronomic measurements collected at the Purdue Agronomy Farm for the 1979 field research experiments.

---

Agronomic Measurements

---

Crop Development Stage

Amount of Vegetation

Plant Height  
Percent soil cover  
Number of plants per square meter  
Number of leaves per plant  
Leaf area index  
Total fresh and dry biomass( $\text{g}/\text{m}^2$ )  
Dry biomass of leaves, stems, and heads, ears or pods ( $\text{g}/\text{m}^2$ )

Crop Condition

Percent leaves green, yellow, and brown  
Plant water content ( $\text{g}/\text{m}^2$ )  
Presence and severity of stress

Soil Background Condition

Percent moisture  
Munsell color  
Roughness

Additional Data for Specific Experiments

Leaf nitrogen and chlorophyll concentrations (wheat and corn nitrogen fertilizer experiments)  
Leaf water potential (moisture stress experiments)  
Leaf blight infection levels (corn blight experiment)

Grain Yield

---

Table B-4. Summary of 1979 data acquisition by the Exotech 20C spectroradiometer system at the Purdue Agronomy Farm.

		Experiment					
Measurement Date		Winter Wheat	Corn Nitrogen	Corn Leaf Blight	Moisture Stress	Soybean Cultural Practices	Other Crops
Week Ending		Number of Observations					
May	5	39	-	-	-	-	-
	12	38	-	-	-	-	-
	19	38	-	-	-	-	-
	26	-	-	-	-	-	-
June	2	38	-	-	-	-	-
	9	38	-	-	-	-	-
	16	87	16	-	10	-	-
	23	38	18	-	6	-	-
	30	37	16	-	8	-	9
July	7	38	29	-	-	-	-
	14	-	15	3	-	-	-
	21	-	32	19	-	3	-
	28	-	-	-	-	-	-
Aug.	4	-	15	-	-	-	-
	11	-	-	9	4	17	3
	18	-	15	-	-	-	-
	25	-	-	-	-	-	-
Sept.	1	-	-	-	-	-	-
	8	-	16	7	-	-	-
	15	-	16	-	-	-	-

Table B-5. Summary of 1979 data acquisition by the Exotech 100 field radiometer system at the Purdue Agronomy Farm.

Measurement Date	Experiment							Instrument Altitude
	Winter Wheat	Corn Cultural Practices	Soybean Cultural Practices	Soil Background	Other Crops	Row Direction		
Week Ending		Number of Observations						
May 19	82	48	-	4	-	-	-	
26	-	-	-	-	-	-	-	
June 2	40	56	20	-	-	-	-	
9	60	80	48	20	-	-	-	
16	120	240	204	60	-	-	-	
23	60	80	104	20	-	-	-	
30	60	160	208	40	6	-	-	
July 7	60	80	100	20	8	-	-	
14	-	80	52	20	4	-	-	
21	-	160	156	40	6	40	-	
28	-	-	-	-	-	-	-	
Aug. 4	-	58	-	10	-	-	-	
11	-	80	-	20	-	-	-	
18	-	40	104	10	2	350	-	
25	-	-	-	-	-	-	-	
Sept. 1	-	40	-	10	-	1008	-	
8	-	80	104	20	12	22	-	
15	-	80	104	20	12	20	986	
22	-	80	104	20	12	1532	-	
29	-	80	104	20	8	40	-	
	-	-	-	-	-	-	-	
Nov. 3	40	40	-	10	18	-	-	

Exotech 100 is given in Tables B-4 and B-5, respectively. Crop maturity stages from seedling to senescence for 1979 are represented in these data.

#### 1.4 Data Preprocessing

Preprocessing of the 1978 Exotech 20C spectrometer data and the Exotech 100 Landsat band radiometer data collected at the Purdue Agronomy farm were completed during this year. Preprocessing of the 1978 FSS data collected at the Hand County, South Dakota, intensive test site were also completed.

A major portion of the data collected at the Purdue Agronomy Farm during 1979 has been completed and is available for analysis. All the Exotech 100 data from May through July have been processed. Additional agronomic data will be added to the identification records as it becomes available.

#### 2. Data Acquisition and Preprocessing for Other Test Sites

Field research test sites utilized in 1979 in addition to the Purdue Agronomy Farm included Hand County, South Dakota, Webster County, Iowa and the University of Nebraska Agriculture Research Station in McPhearson County, Nebraska. The Iowa and Nebraska test sites were added during 1979 to expand the corn and soybean test sites. The major crops at the Hand County test site are small grains (spring and winter wheat).

The test sites in South Dakota and Iowa represented commercial fields. The major spectral systems were the NASA/JSC helicopter-mounted spectrometer (FSS) and aircraft multispectral scanner systems. The Nebraska test site included controlled plots of corn moisture stress and irrigation experiments. The NASA/JSC aircraft multispectral scanner was the major spectral system used in Nebraska.

At the South Dakota test site the FSS and aircraft scanner systems

collected three flightlines of data totaling eighteen flightline miles. At the Iowa test site, the FSS and aircraft scanner systems collected data over five flightlines totaling 25 miles. At the Nebraska test site the aircraft scanner collected data over one flightline at 490 meters above the plots.

Aircraft scanner data and helicopter mounted spectrometer data were collected during nearly every scheduled mission. A summary of the data collection by test site for the Field Spectrometer System and the aircraft multispectral scanners is given in Tables B-6 and B-7, respectively. It should be noted that on August 30 at the Webster County, Iowa, intensive test site both 11 channel MMS data and 8 channel NS-001 data were collected. The NS-001 scanner includes the thematic mapper wavelength bands. Data from the two scanners can be compared.

Table B-6. Summary of 1979 crop year data acquisition by the NASA/JSC helicopter-mounted field spectrometer system (FSS).

Mission Date	Test Site	
	Hand Co. S. Dakota	Webster Co. Iowa
Data Acquisition Date		
<u>1978</u>		
Sept. 20-22	9/21	
Oct. 24-28	10/26	
<u>1979</u>		
April 17-19		-
24-27	-	
May 8-12	-	
14-16		5/15
23-25		5/23
May 30 - June 3	6/1	
June 10-12		6/11
19-23	6/21	
28-30		6/29
July 10-14	-	
16-18		7/16,17
24-28	7/25	
Aug. 3-5		8/4
7-11	8/11	
21-23		-
Aug. 30 - Sept. 1		8/30
Sept. 17-19		9/17
26-28		9/27
Oct. 23-25		10/25
Nov. 1-3		11/2

- Indicates that data were not obtained due to inclement weather.



Table B-7. Summary of 1979 crop year data acquisition by the NASA/JSC aircraft multispectral scanners.<sup>+</sup>

Mission Date	Test Site		
	Hand Co. S. Dakota	Webster Co. Iowa	McPhearson Co. Nebraska
Data Acquisition Date			
April 24-27	-		
May 8-12	-		
30-June 3	6/2		
June 19-23	-		
July 10-14	7/10		
16-20		7/16	7/20
24-28	7/25		
Aug. 30 - Sept. 1		8/30*	8/30*

-Indicates that data were not obtained due to inclement weather or aircraft breakdown.

<sup>+</sup>MSS scanner used unless noted otherwise.

\*Both the MMS and NS001 scanner were used.

### C. DEVELOPMENT OF MULTIBAND RADIOMETER SYSTEM\*

Barrett F. Robinson

#### 1. Introduction

To develop the full potential of multispectral data acquired from satellites, increased knowledge and understanding of the spectral characteristics of specific earth features is required. Knowledge of the relationships between the spectral characteristics and important parameters of earth surface features can best be obtained by carefully controlled studies over areas, fields, or plots where complete data describing the condition of targets is attainable and where frequent, timely spectral measurements can be obtained. The currently available instrumentation systems are either inadequate or too costly to obtain these data. Additionally, there is a critical need for standardized acquisition and calibration procedures to ensure the validity and comparability of data.

The objective of this task is to develop a multiband radiometer system for agricultural remote sensing field research. The radiometric instrument will be a multiband radiometer with 8 bands between 0.4 and 12.5 micrometers; the data acquisition system will record data from the multiband radiometer, a precision radiation thermometer, and ancillary sources. The radiometer and data handling systems will be adaptable to helicopter, truck, or tripod platforms. The system will also be suitable for portable hand-held operation. The general characteristics of the system are that it will be: (i) comparatively inexpensive to acquire, maintain, and operate; (ii) simple to operate and calibrate; (iii) complete with the data handling hardware and software and (iv) well-documented for use by researchers.

---

\*This section describes the results of work conducted under Task 2.1C Development of Multiband Radiometer Systems. Professor L. F. Silva and D. P. DeWitt of Purdue/LARS and M. T. Heidt and Richard Juday of NASA/JSC contributed to the preparation of the RFQ and Statement of Work. Roy Tsuchida developed and directed the construction of the pick-up truck mounted boom. Professor D. P. DeWitt and Shirley Davis of Purdue/LARS contributed to the User Manuals. Development of the software was directed by Larry Biehl and was accomplished by Cathy Kozlowski. Development of interface software was accomplished by C. S. Linn.

The instrument system will be a prototype of an economical system which can be utilized by many researchers to obtain large numbers of accurate, calibrated spectral measurements. As such, it is a key element in improving and advancing the capability for field research in remote sensing.

This report describes the design specifications of the multiband radiometer and data recording modules, preparation of system and user's manuals, construction of a truck-mounted boom, and development of data handling software.

## 2. Description of the Multiband Radiometer

The multiband radiometer will simultaneously produce analog voltages which are proportional to scene radiance in each of eight spectral bands. The radiometer will be a stand-alone device capable of operation with a variety of data acquisition systems. The prototype radiometer will be capable of operation from  $0^{\circ}$  to  $60^{\circ}\text{C}$ , when mounted on a tripod, truck, boom, helicopter, or small plane.

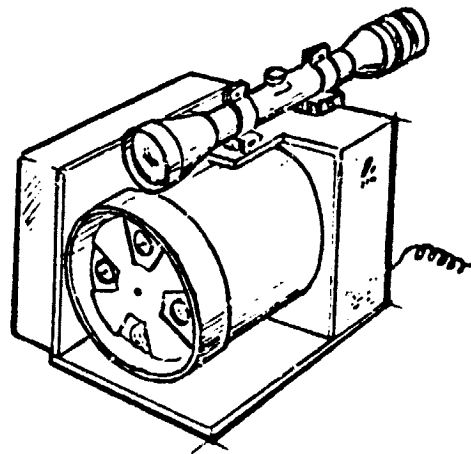

Figure C-1. Sketch of Multiband Radiometer

To achieve reliability in reflectance measurement, a field calibration procedure using a reference surface is to be employed for the reflective spectral bands (refer to section F). For the thermal channel, direct field comparison with two reference blackbodies at known temperature will be used to establish the thermal radiance scale.

2.1 Specifications and Features of the Multiband Radiometer

Spectral Bands. The prototype unit will be equipped with a standard set of spectral bands which match, as nearly as is practical, the seven bands of the Thematic Mapper multispectral scanner. Filters will be durable and suitable for use under field conditions of temperature and humidity. A summary of the spectral bands is shown in Table C-1 and Figure C-2.

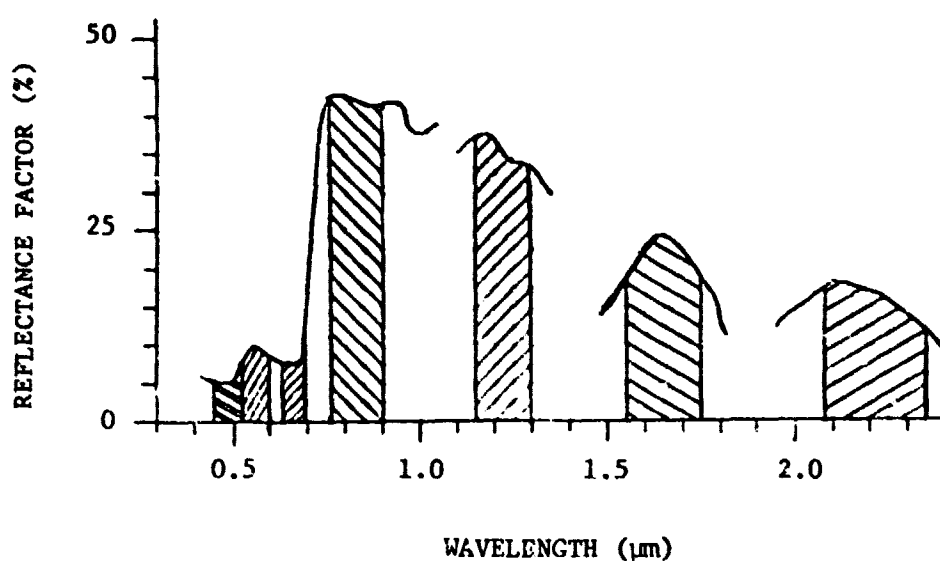

Figure C-2. Spectral distribution of passbands superimposed on a typical vegetation spectrum.

Table C-1. Spectral Band Specification

Band	50% Response Wavelengths (μm)	Detector	L* W·m <sup>-2</sup> ·sr <sup>-1</sup>
1	0.45 - 0.52	Silicon	31
2	0.52 - 0.60	Silicon	27
3	0.63 - 0.69	Silicon	25
4	0.76 - 0.90	Silicon	45
5	1.55 - 1.75	PbS	16
6	2.08 - 2.35	PbS	6
7	10.40 - 12.50	LiTaO <sub>3</sub>	8-32
8	1.15 - 1.30	PbS	21

Examination of Figure C-2 will show that, while the four Landsat bands (0.5-0.6; 0.6-0.7; 0.7-0.8; 0.8-1.1  $\mu\text{m}$ ) sample the vegetation spectrum coarsely and over a limited range, the seven Thematic Mapper bands provide complete and rather detailed coverage of the spectrum. Table C-1 and Figure C-2 show the eighth spectral band (1.15-1.30  $\mu\text{m}$ ) which was selected by LARS agronomists on the basis of spectrometer studies.

Field of View. The instrument will be equipped with co-aligned fields of view ( $1^\circ$ ,  $15^\circ$ , and diffuser) which may be exchanged under field conditions (see Figure C-3).

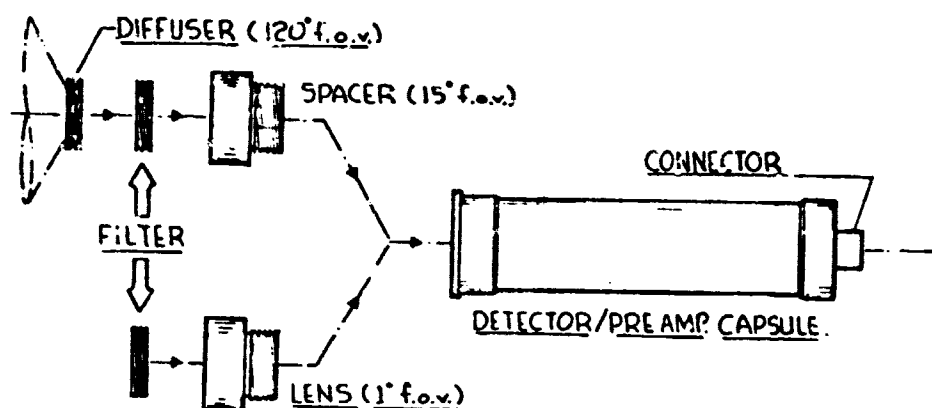

Figure C-3. Optical/electronic module of multiband radiometer.

Dynamic Range. The reflective channels will have adjustable ranges (0.2, 0.5, 1.0, 1.5, 2.0, 3.0 and 5.0) which will be internally adjusted so that radiance of  $L^*$  (see Table C-1) will produce a response of 3 volts in the 0 to 5 volt output range for a gain setting of 1.0.  $L^*$  is determined to be the nominal in-band radiance of a perfectly diffusing diffuser normal to the irradiance at sea level on a clear day ( $m=1$ ).

The thermal channel will have a single range of in-band radiances corresponding to blackbody temperatures from  $-20^\circ\text{C}$  to  $+70^\circ\text{C}$  which will produce voltages in the 0 to 5 volt range.

Chopping Arrangement. The multiband radiometer will consist of eight modular optical-electronics units centered on a 10.16 cm circle. The front-mounted chopper will limit the entry of radiance flux to the optical modules (see Figure C-4).

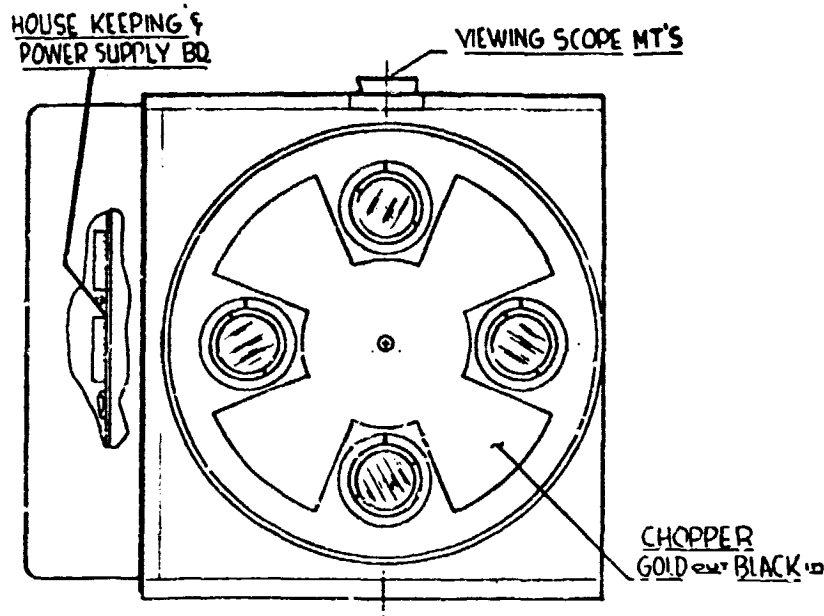

Figure C-4. Chopping arrangement for the multiband radiometer.

Modularity. The multiband radiometer will be suitable for reconfiguration in field environments. Detector/preamp capsules 14 cm in length will be plugged into a mother board. Lenses, filters, and spacers will screw into the capsule as indicated in Figure C-4.

Controls and Display. The gain of each reflective channel will be selectable by a panel mounted switch. A panel mounted analog meter will display channel output voltages as selected by a panel mounted switch.

Gain Status Signals. On command from an external source (TTL zero) the output from each reflective channel will be switched from data signal to an analog voltage indicating the gain setting of the channel. This feature is useful when the radiometer is mounted on the end of a long boom and for reading the gain of the channel into a data logging device.

Camera Boresight. The instrument will be equipped with a mount suitable for boresighting a 35mm camera to  $0.3^\circ$  of the optical axis.

Camera Control. A camera control signal will be fed, through the input cable, to a jack on the exterior of the electronics case to enable remote camera operation.

Low Battery Warning Signal. The multiband radiometer will provide a TTL zero signal when the battery is judged to be too low for accurate operation.

System Temperature Signals. Several temperature monitoring devices will be imbedded in the prototype multiband radiometer for monitoring system temperatures.

Electronic Filtering. Each channel will be equipped with 4 Hz and 20 Hz filters which are internally selectable.

Measurement Precision. The performance of the reflective channels is limited by demodulation noise and gain drift due to temperature changes. Detector temperatures will be monitored and analog compensation will be used to limit the relative limit of uncertainty in reflectance measurement to 1% (silicon) and 2% (lead sulfide) for a 5 Celsius degree step in temperature imposed for 20 minutes (20 Hz filter).

The thermal channel will also be compensated and the temperature of the chopper monitored to produce an  $\Delta T$  of less than 0.5 Celsius degrees for the above conditions.

Weight and Volume. 15.24 x 20.32 x 13.65 cm<sup>3</sup>  
Less than 3 Kg (production system)  
3.5 Kg prototype.

Power. The instrument will be powered by any 12 volt battery and protected for vehicular battery operation. Two separate 12 volt rechargeable batteries which may be carried in a "fanny pack" will be supplied. A charger will be provided to recharge the batteries. Battery life will be greater than 3 hours in continuous service.

Cables. Connecting cables, 1.2m and 15m will be provided for hand-held and boom operation, respectively.

## 2.2 Development and Acquisition of Multiband Radiometer

During the first and second quarters, specifications for the multiband radiometer and the data recording module were finalized. The Request for Quotation (RFQ) was prepared in concert with the Technical Monitor and consultants familiar with the procurement of optical instruments. The RFQ was issued by Purdue University on May 3, 1979. Fifteen vendors for the radiometer and eight vendors for the data recording modules were encouraged to bid on all or part of the system. Two proposals were received for the multiband radiometer and one proposal was received for the data recording system. The proposals were evaluated in concert with the Technical Monitor and it was decided to award the contract for production of the prototype multiband radiometer to Barnes Engineering Co., Stamford, CT. Delivery is anticipated by mid-July 1980.

In order to realize the advantages of multiple unit pricing for the optical filters for a multiple-radiometer program (and to limit risk on the part of the vendor where only a single prototype radiometer was being placed under contract) it was decided (in concert with the Technical Monitor) that LARS and Barnes would cooperate in the selection of vendors for the optical filters and preparation of the purchase specifications. LARS would then purchase the filters and Barnes would perform acceptance evaluation and warrant instrument performance.

Following the preparation of the Preliminary Design Report (meetings with vendor are scheduled for November 29 and 30, 1979), the selection of filter vendors should be completed near the start of the next contract year.

### 3. Description of the Data Recording Module

The Data Recording Module (DRM) will digitize, format, and store analog data in a solid state memory. The DRM will accept analog signals from the



multiband radiometer and other sources as appropriate to the measurement situation. It will operate under the same environmental conditions as the multiband radiometer.

The main function of the DRM is to record the data from the multiband radiometer and other data channels within 2.5 milliseconds - corresponding to 15 cm at 61 meters per second. Additionally, the unit will provide a suitable interface for a printing calculator to allow on-site evaluation of system performance and to provide a means for analysis of limited quantities of data (typically, a H.P. 97S will require about 30 seconds to process a single observation (all channels) to the desired final form and print the results. The principal transfer mechanism will be 16 bit parallel with handshake which is well suited for entry to many micro-processors and computers. A parallel to serial conversion may be required for some systems but can be easily accomplished external to the DRM.

### 3.1 Specifications and Features of the Data Recording Module

#### Data Acquisition

Data Inputs: 15 single ended channels  
> 10 M $\Omega$  input impedance

Resolution: 12 bits

Accuracy:  $\pm 1$  bit (0 $^{\circ}$ C to 60 $^{\circ}$ C)

Stored Data (4K increments to 64K - 16 bit static RAM with data retention battery)

Year, Day of Year, Time, Observation Number (auto advance), up to 15 channels of data and radiometer channel gain (optional), will be recorded for each observation.

Data Retention: 30 days

#### Data Output

Display: Memory contents

Transfer: Memory contents direct to parallel input port on digital computer or translating device. Memory contents may be directed to printing calculator such as the Hewlett-Packard 97S for on-site computation of reflectances, radiances, and temperatures.

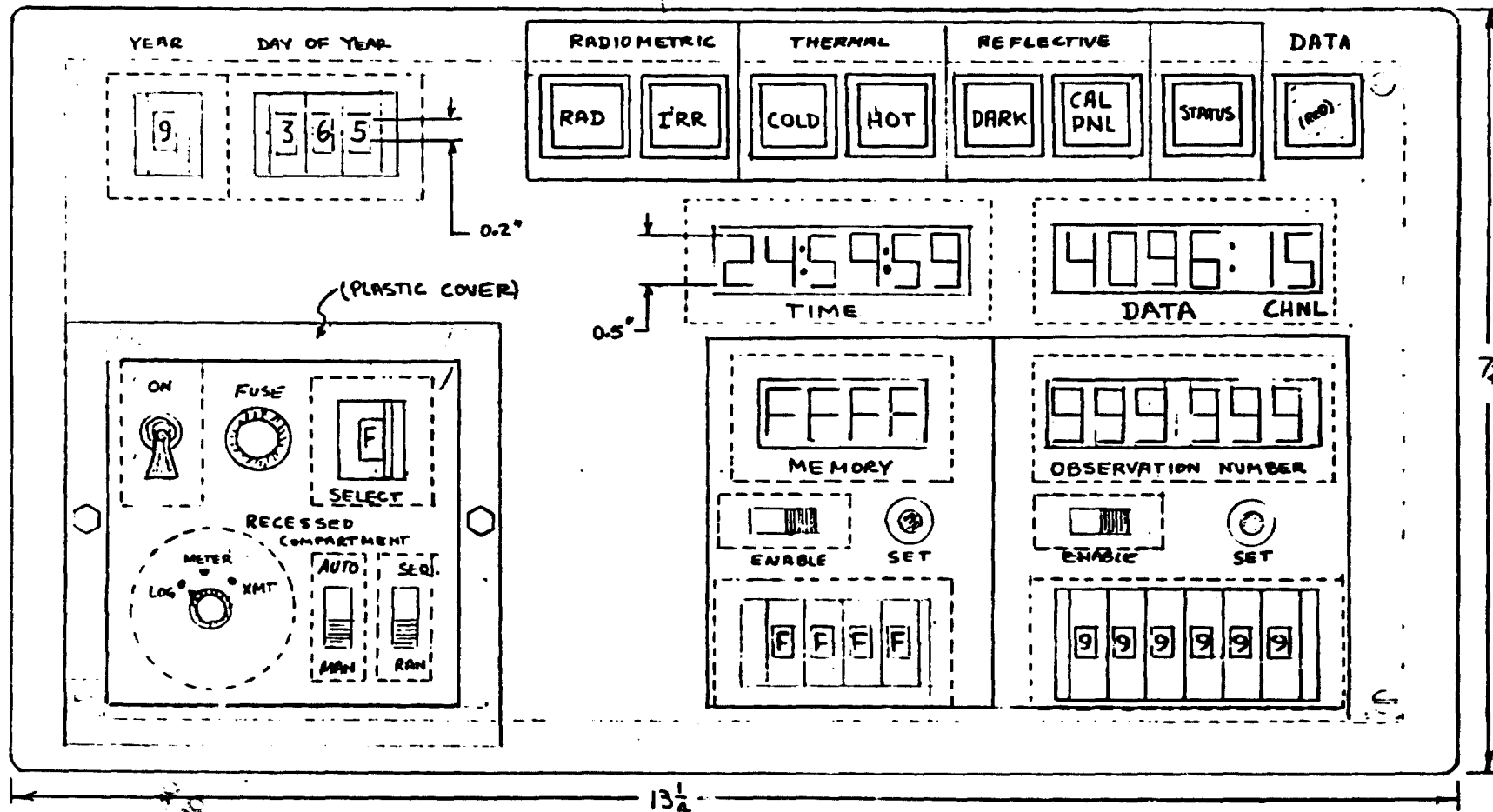

Figure C-5. Sketch of Front Panel of Data Recording Module.

ORIGINAL PAGE IS  
 IN FOOD DOCUMENTS

### Control Functions

Intervalometer Action. Based on internal clock, adjustable timing intervals for acquisition of data and activation of camera from 0.1 to 10 seconds will be provided.

Data/Gain Status control for radiometer gain interrogation

Low Batter Warning - Audible

Channel Over-Range Warning - Audible

Remote Activation of Acquisition

Observation Number (6 BCD characters) available for use by data back camera

### Power

The instrument will be powered by any 12 volt battery and protected for vehicular battery operation. Two separate 12v rechargeable batteries will be supplied. Battery life will be greater than 3 hours in continuous service. A charger will be supplied to recharge the batteries. Batteries will be external to the logger case.

### Weight and Volume

The logger will be light enough to hand carry with the radiometer. Battery and logger may be strapped to user and comfortable to carry.

### 3.2 Development and Acquisition of Data Recording Module

Due to the high cost of the prototype data recording module proposal received, it was decided that Purdue/LARS would build the prototype data recording module. The initial design is completed and the major parts are on order. Completion by June 1980 is estimated.

### 4. Construction of Truck-Mounted Boom

As part of the task, a pick-up truck-mounted boom was constructed. A discussion of the trade-offs in the mechanical design, appropriate stress

computations, and a description of the boom are documented in LARS Technical Report 090879, Design and Evaluation of a Pick-up Truck-Mounted Boom for Elevation of a Multiband Radiometer System, by Roy Tsuchida. The specifications for the boom design incorporate several years of field experience by LARS with similar structures. Except for discussion of performance tests, which will be conducted when construction of the boom is completed, this document is complete and has been supplied to the Technical Monitor. The boom assembly and its operation are shown in Figures C-6 and C-7.

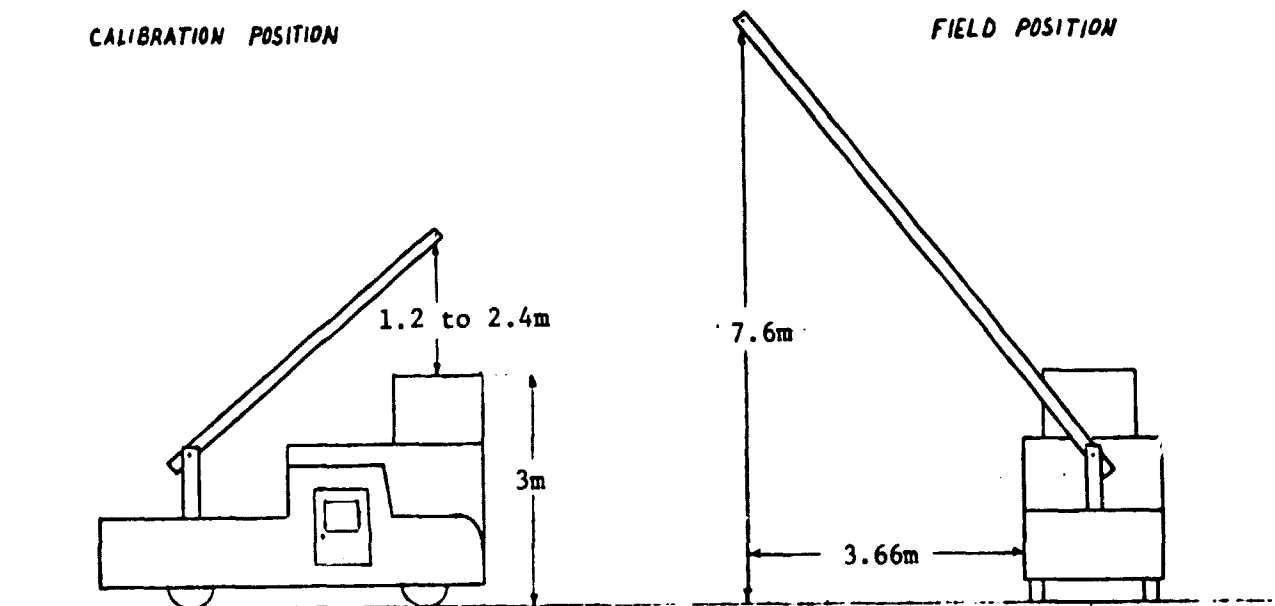

Figure C-6. Positioning of the pick-up truck-mounted boom.

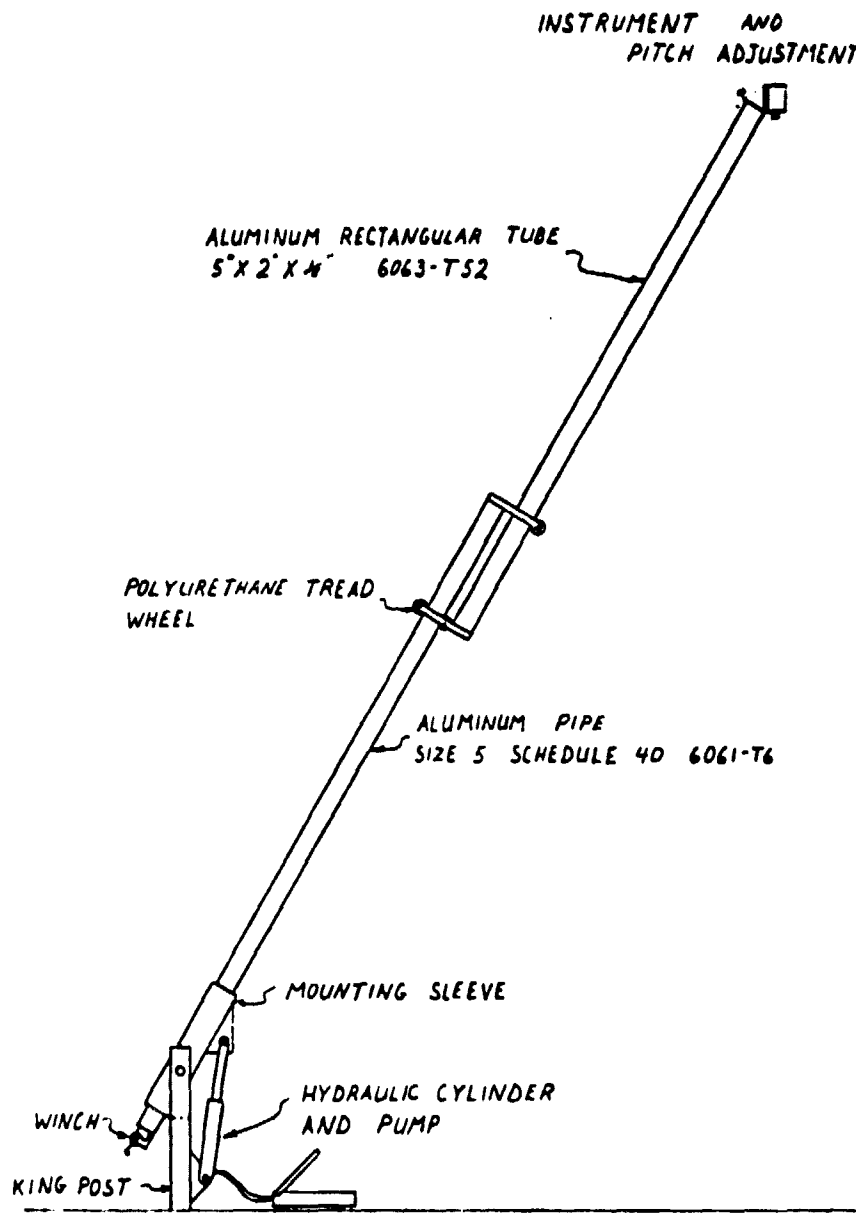

Figure C-7. Sketch of pick-up truck-mounted boom.

## 5. System and User Manuals

System manuals are being prepared for the multiband radiometer and data recording modules. Each manual includes the following topics:

- General Information (description, specifications, etc.)
- Installation
- Operation
- Theory of Operation
- Maintenance and Repair
- Testing Procedures

A detailed outline of the system manual has been prepared and provided to the Technical Monitor. It supersedes the version supplied at the time of the second quarterly report.

In addition, a users manual is being prepared to provide information to researchers and system users on the following topics:

- Fundamentals of Measurement and Calibration
- Field Measurement and Calibration Procedures
- Performance Evaluation Tests
- Experimental Design (including a sample experiment)

A detailed outline and partial draft of the User's Manual for Agricultural Researchers has been supplied to the Technical Monitor.

## 6. Development of Data Handling Software

A software system was designed and implemented to aid in the handling and preprocessing of multiband radiometer data along with associated agronomic, meteorological, and other ancillary data. The software system was initially built around an Exotech 100 Landsat band radiometer system and later made more general for any multiband radiometer system having one to twelve channels.

The software system presently uses 80 column computer cards for radiometer data input. Presently for the Exotech 100 system, the data is recorded on printed paper tape, copied to 80 column record sheets, and

keypunched. The program is designed, however, to accept data input directly from the Data Recording Module. Examples of the record sheet inputs are given in Figures C-8 thru C-10.

The software system calibrates the data according to one of several algorithms selected by the researcher. The algorithms presently include:

- Inband Bidirectional Reflectance Factor - direct scene to reference comparison
- Inband Bidirectional Reflectance Factor - scene to reference comparison with sun angle correction
- Inband Bidirectional Reflectance Factor - scene to interpolated comparison between two reference observations
- Inband Transmittance
- Direct Ratio of Two Observations

The software system also accepts other logger recorded data such as radiant temperature and air temperature probe measurements. These measurements are calibrated as specified by the researcher and stored with the calibrated spectral measurements.

The processed multiband radiometer data are stored on tape in a format that is compatible with the LARSPEC software for researcher data access and analysis. The processed data include agronomic measurements, meteorological measurements, instrument parameters, and experiment identifiers. These other measurements are entered via the same record sheets used for processing the Exotech 20C data.

The software system is documented and will be updated as needed. A copy of the table of contents of the Multiband Radiometer Reformatting Software Manual is given in Figure C-11. Presently the software system has been tested using the Purdue/IARS Exotech 100 system data from 1978 and 1979 via computer cards as input. Additional tests and software revisions will be made when the data acquisition module becomes available.





Purdue/LARS Multiband Radiometer Calibration Sheet

(Revised 4/04/79)

Investigator  Operator  Yr. Mo. Day    First Observation  Last Observation

Instructions (Ins): Continuous thru (T)  
 Not continuous ( )  
 Not observation (D)

Observation Number	Start	End	Cal. Mode	Cal. Mode	Observations for Calibration						Observations for 'Dark Level'						Band Skip Flags	Serial Number
					I	I	I	I	I	I	I	I	I	I	I	I		
					N	N	N	N	N	N	N	N	N	N	N	N		
					23 24	28 29	33 34		43 44	48 49	53 54							
1																		
2																		
3																		
4																		
5																		
6																		
7																		
8																		
9																		
10																		
11																		
12																		
13																		
14																		
15																		
16																		
17																		
18																		
19																		
20																		

Figure C-9. Multiband Radiometer Data Calibration Sheet

PURDUE/LARS MULTIBAND RADIOMETER RECORD SHEET #1

(Revised 7/19/79)

Investigator	Operator	Yr. Mo. Day Ref.	Illumination	Latitude	Longitude	Flight Line
1	18	35 37 39 41	46	55	64	73
\$				N	W	
First Observation	Last Observation	Field of View		Film	Location	
1	9	18		62	65	
\$						

Data Type - Dark Level (D), Scene Response (S), Reference Response (R), Scene Transmittance (T), Incident Transmittance (I)

Photo - Yes (Y), No (N)  
Film - BW, CO, DR

Left Justify: Investigator, Operator, Illumination, Flight Line, Location, Target Description, Ref., Comments

Observation No.	D U P	12	view angle		photo	Dist. (ft.)	Target Description	cloud cover	Obs. Code	Comments (* don't punch)
			Zen.	Azi.						
1	9 10		32	34	37	39	42	59	61	65
1										
2										
3										
4										
5										
6										
7										
8										
9										
10										
11										
12										
13										
14										
15										
16										
17										
18										
19										
20										
1	9 10	12	32	34	37	39	42	59	61	65
I	A		I	I	A	I	A	I	I	A

Figure C-10. Multiband Radiometer Data Record Sheet

Multiband Radiometer Reformatting Software Manual

Table of Contents

	<u>Page</u>
1. Instructions for Processing Multiband Radiometer Data. . . . .	1-1
1.1 Instructions for Running Reformatting Program. . . . .	1-1
1.2 Description of Processing Output . . . . .	
2. Multiband Radiometer Reformatting Program Descriptions . . . . .	2-1
3. LARS Field Spectrometer/radiometer Data Storage Tape Format. . . . .	3-1
4. Multiband Radiometer Reformatting Algorithms . . . . .	4-1
5. Supporting Tables or Disk Files . . . . .	5-1
5.1 Experiment Names (EXPMENT NAMES) . . . . .	5-2
5.2 Wavelength Band Identification (INSTMENT CODES). . . . .	5-4
5.3 Reflectance Calibration Tables (RFLSTND X100). . . . .	5-7
5.4 Data Conversion Tables (PRT5 X100) . . . . .	5-11
5.5 Ephemeris Data (EPHEM DATA) . . . . .	5-15
5.6 Print Format for IDPRNT (PRINTFMT LARSPEC) . . . . .	5-17
6. Instructions for Completing Data Sheets. . . . .	6-1
6.1 Multiband Radiometer Data Record Sheet . . . . .	
6.2 Multiband Radiometer Calibration Sheet . . . . .	
6.3 Multiband Radiometer Measurement Record Sheet 1. . . . .	
7. Contributors to Multiband Radiometer Reformatting System . . . . .	7-1

Figure C-11. Table of Contents for Multiband Radiometer Reformatting Software Manual

## 7. Interface Hardware and Software

In preparation for entry of data from the Data Recording Module, a DR-11C Bit Parallel I/O Interface and a DD11-DF Back Plane were installed on the Purdue/LARS PDP 11/34A minicomputer. The installation is being brought on line and should be completed early in December 1979. A program for testing the interface has been prepared and additional interface software is on order.

Entered data will be quickly stored in core memory until the entry is complete. Data will then be stored on a disk awaiting transfer from the PDP 11/34A to the IBM 3031 for calibration and reformatting to LARSPEC compatible format.

#### D. ESTABLISHMENT OF SOILS DATA BASE

Eric R. Stoner and Marion F. Baumgardner\*

##### 1. Introduction

Although a large body of knowledge has been accumulated about the physical and chemical characteristics of soils as they are influenced by the soil forming factors of climate, parent material, relief, biological activity, and time, there is only limited knowledge of how these factors relate to the reflected radiation from surface soils. Earlier studies have shown that information about the spectral properties of soils may be useful in their identification and characterization (4,5,6,7).

Modern soil classification systems emphasize the importance of information about the quantitative composition of soils. In order to differentiate among soil groups, it is necessary to rely on laboratory measurements of selected soil properties. Physical and chemical determinations of most soil properties follow well established procedures of laboratory analyses. Based on their importance in understanding the genesis of soil, certain of these soil properties are selected as diagnostic criteria in the soil classification process. By a procedure of empirical correlation, critical limits between sets of soils are established, designed to reflect the influence of the soil forming factors of climate, parent material, relief, biological activity, and time.

Quantitative measurements of soil spectral properties have become available as a diagnostic tool for the soil scientist with the advent of such instruments as the Exotech Model 20C spectroradiometer. However, the climatic and genetic effects on the relationships between measured spectral properties and specific chemical, physical, and biological properties of the soil are not well understood. Whereas soil color is used as diagnostic criterion in the U.S. Soil Taxonomy (8), the determination of soil color by

---

\*The contributions of Richard A. Weismiller, Larry L. Biehl, Barrett F. Robinson, Virgil L. Anderson, John B. Peterson, Lou M. Nash and Lyn T. Kirschner to the experiment design, data collection and data analysis for Task 2.D Establishment of Soils Data Base are gratefully acknowledged.

comparison with a color chart continues to be a rather nonquantitative and subjective procedure. Spectral characterization of soil "color" by means of quantitative spectroradiometric measurements may add to the precision with which soils can be differentiated. With this increased precision of soil spectral characterization, the relationships with the more important diagnostic soil characteristics or qualities that are not so easily and accurately observed may be better understood.

A study was, therefore, initiated in 1977 to develop a data base of soil reflectance and physical-chemical properties and investigate the relationships of reflectance and important physical-chemical properties of soils (1). During the current year the data base and initial statistical analysis of the data have been completed and are summarized in this report. Two, more detailed technical reports (2,3) describing the results of the investigation have also been prepared.

## 2. Study Objectives

The general objective was to define quantitatively the relationships between soil reflectance and physicochemical properties of soils of significance to agriculture. Selection of soil samples with a wide range of important soil characteristics by statistical stratification of continental United States climatic zones permits the evaluation of climatic and genetic effects on the relationships between multispectral reflectance and these soil properties. A further objective was to define the relationships sufficiently to design further research to quantify the contributions which different soil components make to the multispectral characteristics of specific soils. The ultimate objective of this research approach is to provide a body of knowledge in the form of a soils data base which will render remote multispectral sensing a valuable tool for mapping soils, determining land use capabilities and soil productivity ratings, identifying crops and predicting crop yields.

### 3. Experimental Approach

#### 3.1 Stratification and Sampling

Approximately 250 soils, representing a statistical sampling of the more than 10,000 soil series in the United States were selected for this investigation. Selections were made from a list of the more than 1300 Benchmark soil series representing those soils with a large geographic extent and whose broad range of characteristics renders these soils so widely applicable for study.

Stratification of soil sampling was based on series type location within climatic zones. Climatic strata included the frigid, mesic, thermic, and hyperthermic soil temperature regimes as defined by the U.S. Soil Taxonomy (8,9,10) as well as the perhumid, humid, subhumid, semiarid, and arid moisture regions as identified by Thornthwaite's 1948 Moisture Index (11). A random selection procedure was used within each stratified climatic zone to select a number of soils series approximately in proportion to the geographic extent of that region (Figure D-1).

#### 3.2 Collection of Soil Samples

The Soil Survey Investigation Division of the Soil Conservation Service (USDA) cooperated with the Laboratory for Applications of Remote Sensing, Purdue University by taking responsibility for field collection of almost 500 individual soil samples from 190 counties within 39 states. Two separate soil samples were collected for each soil series, one at a site near the type location for the current official series, and another at a site from one to twenty miles distant from the first site in a different mapping delineation of the same series. Samples were forwarded to Purdue University complete with additional site information regarding exact sampling location, physiographic position, slope, drainage, vegetation, and parent material. Brazilian soils were sampled in connection with a soil survey of Paraná State, Brazil (12).

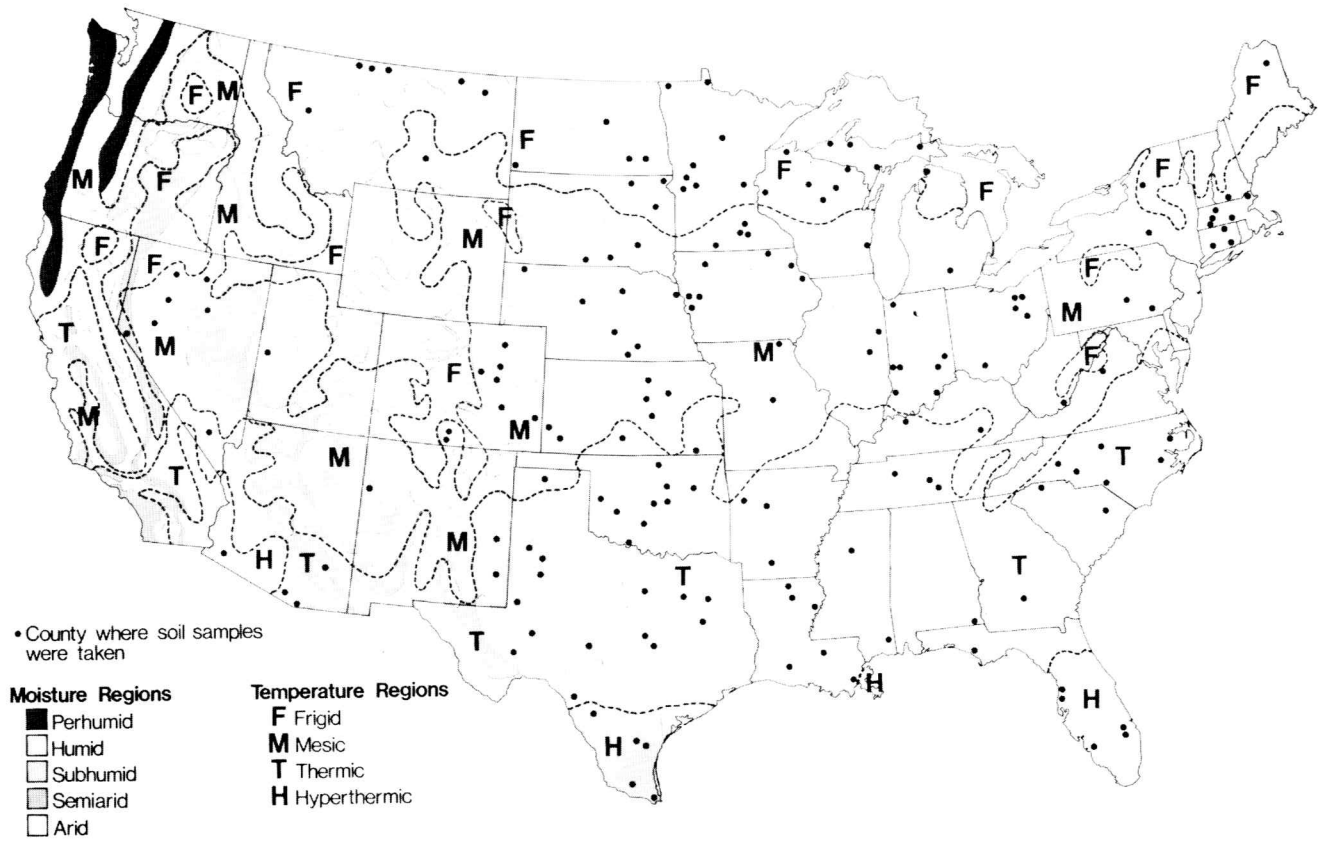

Figure D-1. Climatic zones in the continental United States as identified by soil temperature regime (Soil Survey Staff, 1975; FAO-UNESCO, 1975) and the Thornthwaite (1948) moisture index.



### 3.3 Measurement of Soil Reflectance Properties

The sieved soil fraction less than 2 mm diameter was used for reflectance measurements in an attempt to standardize this procedure in line with the use of this same size fraction for most laboratory determinations of soil properties. All measurements were made on uniformly-moist soils which were equilibrated for 24 hours at a one-tenth bar moisture tension on asbestos tension tables. Specially constructed 10 cm diameter by 2 cm rings with 60 mesh wire bottoms held the soil in place through the stages of saturation, equilibration, and spectral reading.

Soil reflectance was measured using an Exotech Model 20C spectroradiometer adapted for indoor use with a reflectometer equipped with an artificial illumination source, transfer optics, and sample stage. Spectral readings were taken in 0.01  $\mu\text{m}$  increments over the 0.52-2.32  $\mu\text{m}$  wavelength range. A 1000 watt tungsten iodine coiled filament lamp provided incident irradiation similar to that of solar illumination. Pressed barium sulfate was used as a calibration standard, with measurements being taken after every fifth soil sample to account for possible changes in the intensity of the illumination source. A more detailed explanation of the instrumentation is found in references 13, 14, 15 and 2.

The repeatable quantitative nature of reflectance measurements made using this procedure is evident from spectral curves of check samples measured on each of the ten days needed to run over 500 individual soil samples (Figure D-2). Random soil reflectance readings of twenty separately prepared Fincastle silt loam soil samples (a fine-silty mixed mesic Aeric Ochraqualf) gave very similar results.

## 4. Soil Properties Data Base

### 4.1 Computer Record

An identification record containing 100 items of information including complete soil taxonomic classification along with site characteristics and laboratory analyses is available in computer tape format for all of the

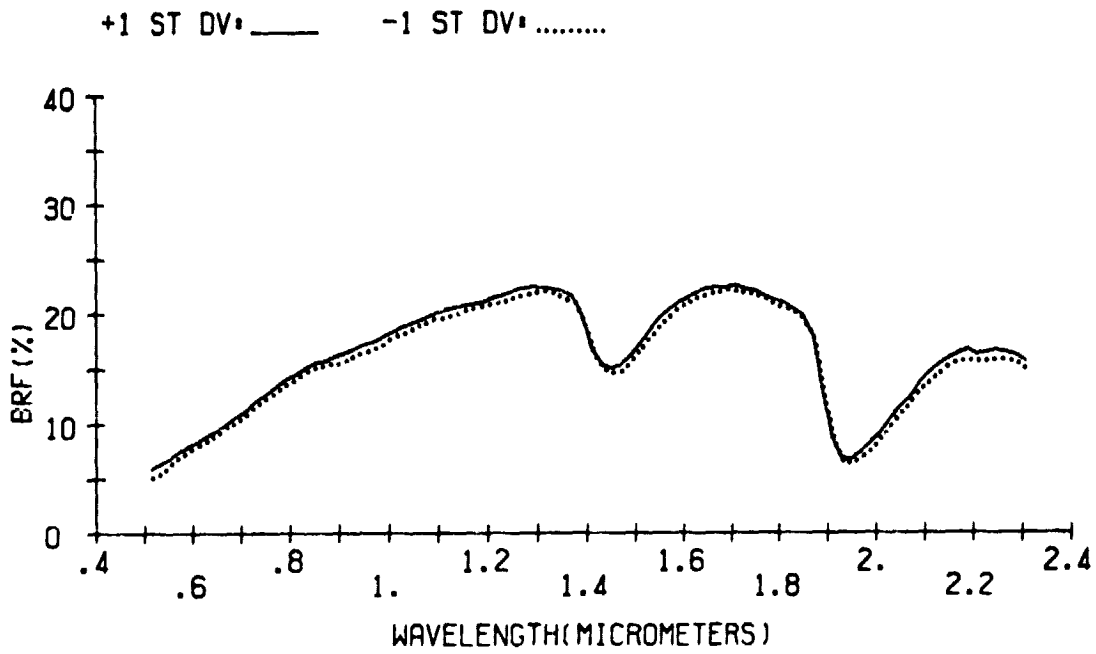

Figure D-2. Spectral curves representing the standard deviations from the average reflectance values for twenty check samples of a silt loam Alfisol measured over ten different laboratory setups.

soils in this study. This information together with digitized soil reflectance data is accessible for editing and rapid retrieval of all soils information by means of the LARSPEC software package (16). Graphical display of soil reflectance curves as shown in this report is accomplished by one of the LARSPEC processors while another processor permits selection of specific soil analyses, site characteristics, and taxonomic data in the abbreviated format used here.

#### 4.2 Soil Atlas

An abbreviated format was chosen for presentation of selected soil properties in an atlas of soil reflectance properties to be published as a LARS Technical Report (3) and as a Purdue University Agriculture Experiment Station research bulletin. Soils are arranged in this atlas by alphabetical order of the 39 states from which they were sampled. Four soils from Paraná State, Brazil follow at the end. Four soils are displayed on each page, while information specific to one of two field samples is given in separate columns under each soil series name. A few soils are represented by only one field sample. A narrative key follows, with each numbered item of soil information identified in Figure D-3 described in detail as it appears in the atlas.

Examples of various soils with widely-differing chemical, physical and spectral properties are illustrated in Figure D-4. These data summaries for twelve soils from seven of the ten soil orders represent only a small part of the data for 251 soils listed in the soil atlas.

#### 4.3 Narrative Key to Soil Information

##### Soil Series Name with Two-Letter State Abbreviation

The series is the lowest category in the soil taxonomic system. Names of series as a rule are abstract place names with no connotation regarding soil diagnostic properties. The atlas contains soil information for 247 of the more than 10,000 soil series recognized in the United States. These 247 soil series were selected from a list of over 1,300 Benchmark soils

1) ONTONAGON (MI)

- 2) Glossic Eutroboralf
- 3) very fine, mixed
- 4) humid zone
- 5) glacial lake plain sediments
- 6) Ontonagon Co.

———	----
7) Ap horizon	Ap horizon
8) B slope	B slope
9) mod. well drained	mod. well drained
10) clay	clay
11) 7XS 22XS1 70XC	6XS 29XS1 66XC
12) 2.5YR 3/6 (moist)	2.5YR 4/4 (moist)
5YR 6/4 (dry)	5YR 6/4 (dry)
13) 4.88% O.M.	3.95% O.M.
14) 38.0 meq/100g CEC	31.6 meq/100g CEC
15) 1.73% Fe <sub>2</sub> O <sub>3</sub>	2.76% Fe <sub>2</sub> O <sub>3</sub>

16) 47.5 MW%: —— 43.2 MW%: ----

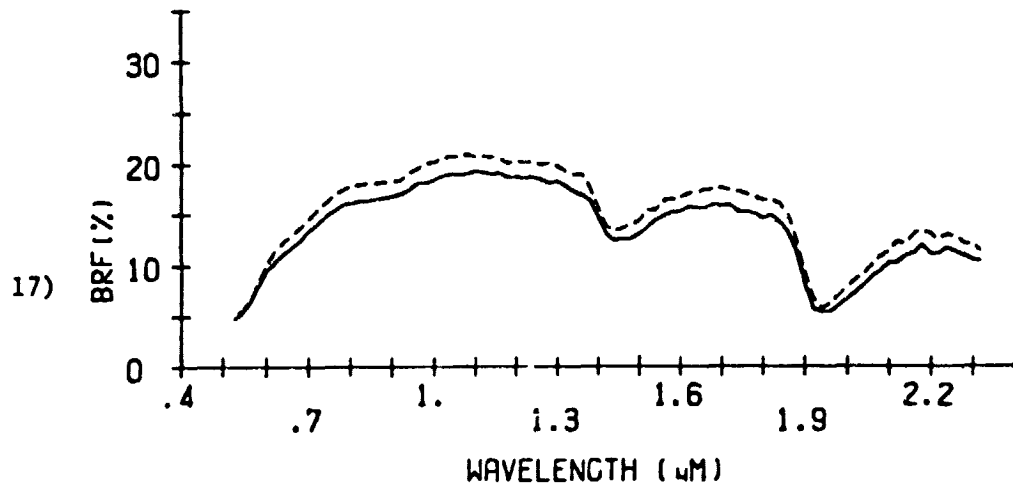
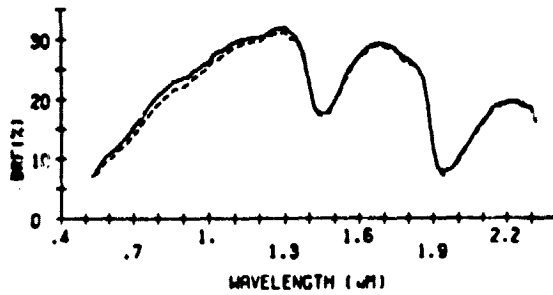

Figure D-3. Numbered guide corresponding to narrative key to soil information.

PRATT(KS)

Psammentic Haplustalf  
sandy, mixed, thermic  
subhumid zone  
sandy eolian deposits  
Pratt Co.

Ap horizon	Ap horizon
B slope	B slope
well drained	well drained
fine sandy loam	fine sandy loam
73S 242S1 32C	61S 372S1 22C
10YR 3/3 (moist)	10YR 4/3 (moist)
7.5YR 6/4 (dry)	7.5YR 6/2 (dry)
0.55% O.M.	0.44% O.M.
2.8 meq/100g CEC	1.9 meq/100g CEC
0.31% Fe <sub>2</sub> O <sub>3</sub>	0.25% Fe <sub>2</sub> O <sub>3</sub>
11.0 MWZ	13.4 MWZ



RICHFIELD(KS)

Aridic Argiustoll  
fine, montmorillonitic mesic  
semiarid zone  
silty eolian sediments  
Grant Co.

Ap horizon	Ap horizon
A slope	A slope
well drained	well drained
silt loam	silt loam
82S 722S1 202C	122S 702S1 182C
10YR 3/2 (moist)	10YR 3/2 (moist)
10YR 5/3 (dry)	10YR 5/2 (dry)
2.14% O.M.	1.78% O.M.
21.4 meq/100g CEC	21.3 meq/100g CEC
0.79% Fe <sub>2</sub> O <sub>3</sub>	0.86% Fe <sub>2</sub> O <sub>3</sub>
37.3 MWZ	35.6 MWZ

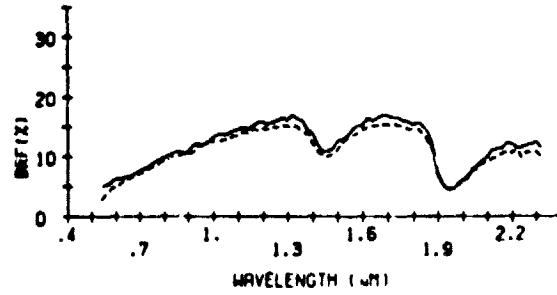

COLBY(KS)

Ustic Torriorthent  
fine-silty, mixed, calcareous, mesic  
semiarid zone  
calcareous silty material  
Hamilton Co.

Ap horizon	Ap horizon
A slope	A slope
well drained	well drained
silt loam	silt loam
222S 542S1 242C	152S 622S1 242C
10YR 5/3 (moist)	10YR 5/3 (moist)
10YR 6/4 (dry)	10YR 6/4 (dry)
1.24% O.M.	0.85% O.M.
30.3 meq/100g CEC	30.2 meq/100g CEC
0.69% Fe <sub>2</sub> O <sub>3</sub>	0.68% Fe <sub>2</sub> O <sub>3</sub>
37.3 MWZ	36.6 MWZ

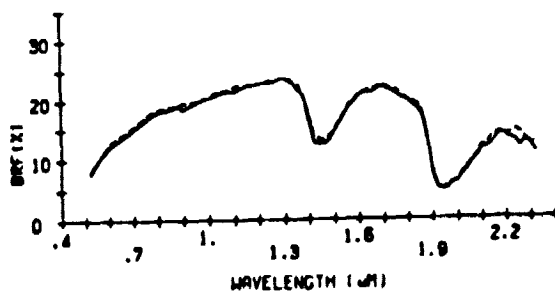

NEWARK(KY)

Aeric Fluventic Haplaquept  
fine-silty, mixed, nonacid, mesic  
humid zone  
mixed alluvium  
Davies Co.

Ap horizon	Ap horizon
A slope	A slope
s. poorly drained	s. poorly drained
silt loam	silt loam
252S 572S1 182C	42S 792S1 182C
10YR 4/2 (moist)	10YR 4/3 (moist)
10YR 6/3 (dry)	10YR 6/4 (dry)
1.83% O.M.	2.84% O.M.
15.7 meq/100g CEC	17.0 meq/100g CEC
1.05% Fe <sub>2</sub> O <sub>3</sub>	1.93% Fe <sub>2</sub> O <sub>3</sub>
29.0 MWZ	34.1 MWZ

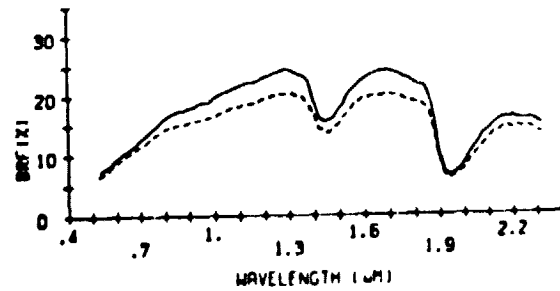

Figure D-4. Reflectance curves, soil test results, and site characteristics in the soil data base.

WHITLEY (KY)

Typic Hapludult  
fine-silty, mixed, mesic  
humid zone  
part alluvium, part acid residuum  
Laurel Co.

Ap horizon	Ap horizon
B slope	B slope
well drained	well drained
silt loam	silt loam
23% 57% 20% C	16% 65% 19% C
10YR 4/3 (moist)	10YR 4/3 (moist)
10YR 6/4 (dry)	10YR 6/4 (dry)
3.50% O.M.	2.17% O.M.
13.7 meq/100g CEC	14.1 meq/100g CEC
1.55% Fe <sub>2</sub> O <sub>3</sub>	2.11% Fe <sub>2</sub> O <sub>3</sub>

18.5 MW% — 35.9 MW% ----

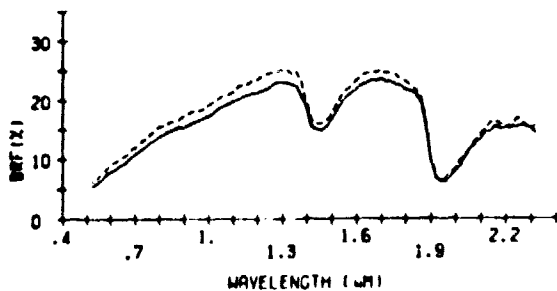

MIDLAND (LA)

Typic Ochraqualf  
fine, montmorillonitic, thermic  
humid zone  
clayey sediments  
Acadia Parish

Ap horizon	Ap horizon
A slope	A slope
poorly drained	poorly drained
silty clay loam	silty clay loam
5% 57% 38% C	3% 63% 32% C
10YR 4/2 (moist)	10YR 3/1 (moist)
10YR 6/3 (dry)	10YR 6/3 (dry)
2.42% O.M.	2.32% O.M.
25.1 meq/100g CEC	27.3 meq/100g CEC
0.88% Fe <sub>2</sub> O <sub>3</sub>	0.62% Fe <sub>2</sub> O <sub>3</sub>

37.7 MW% — 41.2 MW% ----

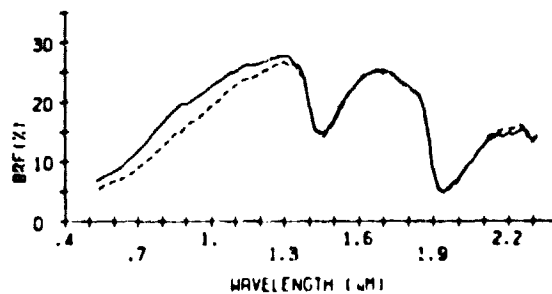

CALHOUN (LA)

Typic Glossaqualf  
fine-silty, mixed, thermic  
humid zone  
loess  
East Baton Rouge Parish

Al horizon	Al horizon
A slope	A slope
poorly drained	poorly drained
silt loam	silt loam
15% 71% 14% C	20% 69% 10% C
10YR 5/3 (moist)	10YR 5/3 (moist)
10YR 7/3 (dry)	10YR 6/4 (dry)
1.74% O.M.	2.40% O.M.
7.1 meq/100g CEC	11.4 meq/100g CEC
0.60% Fe <sub>2</sub> O <sub>3</sub>	0.72% Fe <sub>2</sub> O <sub>3</sub>

34.6 MW% — 33.7 MW% ----

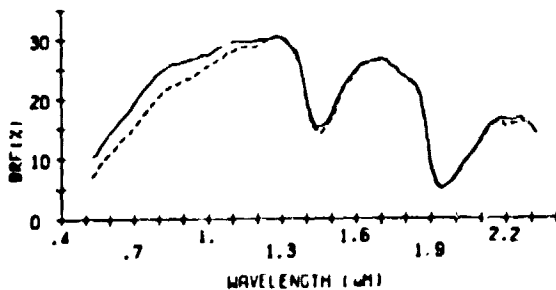

KENNER (LA)

Fluvaquentic Medisaprist  
euic, thermic  
humid zone  
herbaceous plant remains with clayey  
alluvium  
Jefferson Parish

Oel horizon	Oel horizon
A slope	A slope
v. poorly drained	v. poorly drained
muck	muck
4% 40% 56% C	3% 31% 66% C
7.5YR 2/0 (moist)	10YR 2/1 (moist)
10YR 2/1 (dry)	10YR 2/1 (dry)
55.14% O.M.	54.38% O.M.
73.6 meq/100g CEC	82.1 meq/100g CEC
0.00% Fe <sub>2</sub> O <sub>3</sub>	0.00% Fe <sub>2</sub> O <sub>3</sub>

77.2 MW% — 73.1 MW% ----

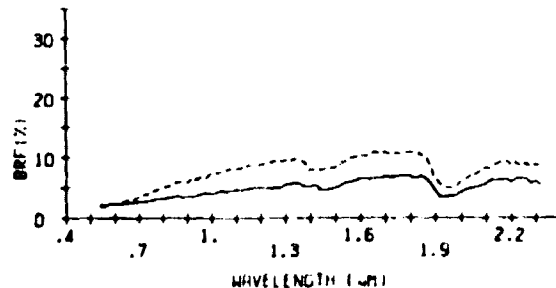

Figure D-4. Continued.

6.3 9.0 14.0 16.0 18.0 20.0 22.0 24.0 26.0 28.0 30.0

CASCADEL (PR, BRASIL)

Haplic Acrorthox  
very-fine, oxidic, thermic  
humid zone  
basalt  
Município of Cascavel

Al horizon  
B slope  
excess. drained  
clay  
152S 182Si 67ZC  
2.5YR 3/3 (moist)  
2.5YR 3/6 (dry)  
3.55Z O.M.  
19.8 meq/100g CEC  
23.3Z Fe<sub>2</sub>O<sub>3</sub>

ORTHOX: \_\_\_\_\_

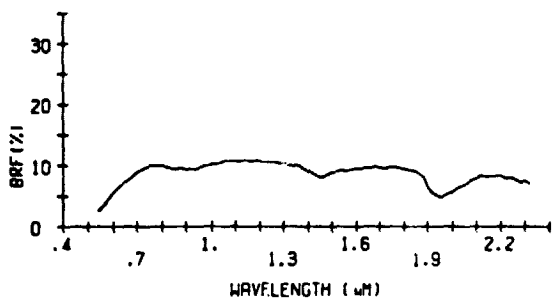

PATO BRANCO (PR, BRASIL)

Haplic Acrorthox  
very-fine, kaolinitic, thermic  
humid zone  
basalt  
Município of Pato Branco

Ap horizon  
B slope  
excess. drained  
clay  
92S 232Si 68ZC  
5YR 3/2 (moist)  
5YR 4/4 (dry)  
3.70Z O.M.  
20.2 meq/100g CEC  
11.2Z Fe<sub>2</sub>O<sub>3</sub>

ORTHOX: \_\_\_\_\_

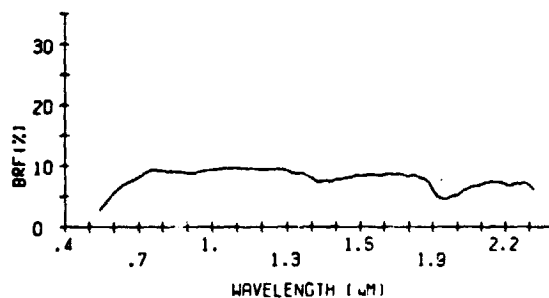

GUARAPUAVA (PR, BRASIL)

Typic Acrohumox  
very-fine, oxidic, thermic  
humid zone  
andesite  
Município of Guarapuava

Al horizon  
B slope  
excess. drained  
clay  
62S 462Si 48ZC  
7.5YR 3/2 (moist)  
7.5YR 4/4 (dry)  
9.23Z O.M.  
41.6 meq/100g CEC  
14.0Z Fe<sub>2</sub>O<sub>3</sub>

HUMOX: \_\_\_\_\_

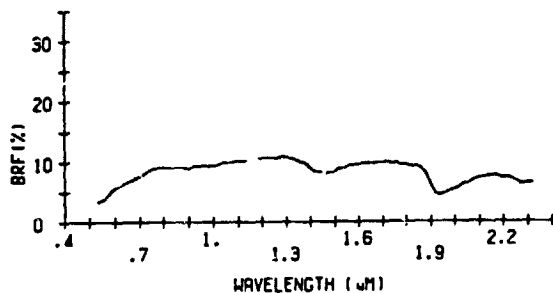

LONDRINA (PR, BRASIL)

Typic Haplorthox  
very-fine, kaolinitic, hyperthermic  
humid zone  
basalt  
Município of Londrina

Allp horizon  
C slope  
excess. drained  
clay  
92S 142Si 77ZC  
2.5YR 3/6 (moist)  
2.5YR 4/6 (dry)  
2.28Z O.M.  
22.1 meq/100g CEC  
25.6Z Fe<sub>2</sub>O<sub>3</sub>

ORTHOX: \_\_\_\_\_

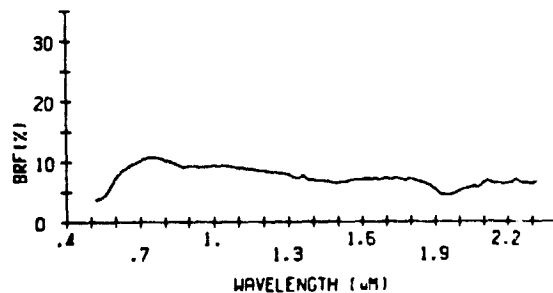

Figure D-4. Continued.

whose large geographic extent renders them an important part of a state or resource area. Soil samples were taken from sites within states having the responsibility for maintaining the standard series description for that soil series. Data from these soils are widely applicable to soils occurring in the continental United States.

#### Soil Subgroup Name

Subgroup names consist of the name of a great group modified by one or more adjectives. About 970 subgroups are currently recognized in the United States. The name of a great group consists of the name of a suborder and a prefix that consists of one or two formative elements suggesting something of the diagnostic properties. There are about 225 great groups in the U.S. soil taxonomy (8). Names of suborders have exactly two syllables. The first syllable connotes some information about the diagnostic properties of the soils while the second is the formative element from the name of the order. Forty-seven suborders are recognized, while there are only ten soil orders.

It has been observed that high organic content surface soils of the Mollisol and Histosol soil order frequently have a concave-shaped reflectance curve in the 0.6 to 1.3  $\mu\text{m}$  wavelength region. Lower organic content surface soils of the Alfisol soil order frequently have convex-shaped reflectance curves in the same wavelength region. Reflectance curves for surface soils of the Ultisol soil order often resemble those for Alfisols except for the presence of slight dips in the curve at 0.7 and 0.9  $\mu\text{m}$  caused by iron absorption. It should be understood that these generalizations about soil reflectance of certain soil orders are only an aid to facilitate the appreciation of differences in spectral properties among surface soils. Soil orders distinguished primarily by subsoil horizon properties cannot always be expected to show characteristic reflectance in the surface horizon.

#### Soil Family Modifiers

Names of soil families are polynomial, consisting of the name of a subgroup and adjectives. These adjectives describe the particle-size



class (11 classes plus others if strongly contrasting), the mineralogy (20 classes and a few subclasses), the temperature regime (8 classes), and, in some families, depth of soil (3 classes), consistence (2 classes), moisture equivalent (2 classes) and other properties. Names of most families have three adjectives modifying the subgroup but some have only one or two and others have four or more. Soil properties are used in this category without regard to their significance as marks of processes or lack of them. About 4,500 families are presently recognized in the United States.

Redundancy is avoided in naming families, thus, for example, the modifier frigid is left out of families in which the formative element bor in the suborder name indicates soils having a frigid temperature regime. Particle-size distribution and mineralogy are specified for only those horizons of major biologic activity below plow depth.

Soils have been observed to increase in reflectance with increasing soil temperature. This is most likely explained by decreased organic matter contents in warmer regions. Lower organic content soils reflect more than those with elevated levels of organic matter.

Soil mineralogy appears to influence soil reflectance in various manners. While soils with gypsic mineralogy reflect highly because of the inherent reflectance properties of gypsum, montmorillonitic soils, often associated with higher organic matter levels, show low reflectance attributable to this high organic matter content.

#### Moisture Zone

Although the soil moisture regime is an important property of a soil, the moisture regimes defined in the U.S. soil taxonomy are not always included in the taxonomic name, and are defined not necessarily by climatic moisture zone, but rather in terms of the ground-water level and the presence or absence of water held at a tension less than 15 bars throughout the year. Moisture zones in this atlas are defined in terms of climatic moisture zones as described by the Thornthwaite moisture index (11). Five main moisture zones are defined on this basis in the continental United States.

Soils from wetter climates generally reflect less than those from dry climates because of organic matter accumulation under higher rainfall conditions. Exceptions to this rule occur when soils are formed under prairie grass vegetation in drier climates.

#### Parent Material

Parent material, as the initial geologic material from which soils are formed, can be expected to demonstrate an eventual influence on soil reflectance. Certain soils referred to as lithochromic are even known to owe their spectral colors to inheritance from the parent material rather than from soil-forming processes. Parent material types listed in the atlas were obtained from the established series profile descriptions for each soil.

#### County

The county within the state where soils were collected is listed in order to specify the sampling location for each of two sets of samples whose analyses follow.

#### Horizon Designation

All soil samples represented only the surface soil, containing material from 0 to 15 cm (0 to 6 inches) if depth to a B horizon permitted. Those surface soils under cultivation or which still show the marks of cultivation are designated by the symbol "p" following the capital letter symbol for the horizon. Undisturbed soils are represented by horizon designations such as A1, A11, A1-A21 and A11-A12.

#### Slope Class

Relief, as expressed by slope class grouping, is an important soil-forming factor that is characteristic of each site in the soil landscape. Slope classes in this atlas follow the convention of capital letter symbols D, 12-18%; E, 18-25%; F, 25-35%; G, greater than 35%.

### Internal Drainage

All soil series have a specific internal drainage which is indicative of the local landscape position and broader climatic conditions under which they formed. Drainage classes used in this atlas are as follows: v. (very) poorly drained, poorly drained, s. (somewhat) poorly drained, mod. (moderately) well drained, well drained, s. excess. (somewhat excessively) drained, and excess. (excessively) drained.

Soils have been seen to show overall decreased reflectance with increasingly poorer drainage. Very poorly drained soils reflect considerably less than any of the other drainage classes at all wavelengths. As a site characteristic integrating the effects of climate, local relief, and accumulated organic matter, soil drainage characteristics are closely associated with reflectance properties of surface soils.

### Textural Class Name

Twenty-one textural class names have been defined in terms of size distribution of five sand size fractions plus silt and clay as determined by mechanical analysis in the laboratory (8). Organic soils are identified by using the term muck in place of the textural class name.

Because textural class names are defined wholly in terms of size distribution, the actual consistence or structure of the crushed, sieved soil samples may not necessarily be conveyed by this name. Highly aggregated clays may in some cases present surface structures similar to that of coarse sands. Use of the textural class name, however, is still the best available convention for expressing the size relationships among soil separates.

### Percent Sand, Silt, and Clay

Particle size analysis was performed on organic matter-free soil portions (17). Clay and silt contents were determined by sedimentation-pipetting while five sand size fractions (here summed to give one sand amount) were separated by passing through a nest of sieves.

Decreasing particle size has been seen to increase soil reflectance among sand textured soils, possibly by forming a smoother surface with fewer voids to trap incoming light. The inverse appears to be true with medium to fine textured soils, however, possibly because increased moisture content and organic matter content associated with higher clay contents lead to lower reflectance.

#### Munsell Color Designations

Color standard comparisons were obtained at two soil moisture levels: air dry and field capacity. Moist soil colors were obtained by moistening samples and reading the color at a point in which visible moisture films were not present. Dry soil colors were obtained on the air dry sieved samples. All soil colors were determined by comparison to standard color chips of the Munsell Soil Color Charts.

Munsell designations for color consist of separate notations for hue, value, and chroma, which are combined in that order to form the color designation. The symbol for hue is the letter abbreviation of the color of the rainbow preceded by numbers from zero to ten. The notation for value, or relative lightness of color ranges from zero, for absolute black to ten, for absolute white. Chroma, or saturation, is the relative purity or strength of the spectral color and increases in number with decreasing grayness.

It is important to remember in comparisons between soil reflectance data and soil colors that the wavelength region of human physiological perception of visible reflectance extends only from about 0.4 to 0.7  $\mu\text{m}$ , while reflectance data presented here extend from about 0.5 to 2.3  $\mu\text{m}$ . While the color imparted to a soil may be due to specific absorptions in the visible region, it may also be caused by intense absorptions outside the visible wavelengths in either the ultraviolet or near infrared, the influence of which may extend into the visible. This points out the importance of having a full range of reflectance data from the visible to the middle infrared for thorough characterization of soil spectral properties.

### Organic Matter Content

Organic matter contents were determined by the modified Walkley-Black procedure of acid dichromate digestion with ferrous ammonium sulfate titration (17). Organic matter appears to be one of the dominant soil parameters responsible for imparting spectral properties to soils. Increased organic matter contents as a rule lead to decreased reflectance throughout the reflective spectrum. Many cases can be seen in this atlas where duplicate soil samples with otherwise similar properties exhibit different reflectance curves because of slight differences in organic matter content.

Although increased organic matter content has been seen to decrease soil reflectance in mineral soils, the form or decomposition stage of organic material is more important in understanding reflectance properties of organic soils. Less decomposed organic materials have higher reflectance in the near infrared region because of enhanced reflectance attributable to remnant cell structure of well preserved fibers. In contrast, very highly decomposed organic materials show very low reflectance throughout the 0.5 to 2.3  $\mu\text{m}$ .

### Cation Exchange Capacity

Cation exchange capacity (CEC) was measured for each soil sample as the sum of extractable cations of Ca, Mg, K, Na, plus extractable acidity, all expressed in terms of milliequivalents per 100 g of soil (17).

Cation exchange capacity is frequently seen to have a high negative correlation with reflectance, especially in the 2.08-2.32  $\mu\text{m}$  middle infrared region. Although there is no direct physical basis for this relationship, it seems that cation exchange capacity is acting as a natural integrating factor for clay type and content as well as organic matter content, soil parameters which exhibit inherent spectral behavior.

### Iron Oxide Content

Free iron was measured by the so-called CBD procedure (17). Ferric iron absorption bands can be seen in certain soil reflectance curves in the

0.7 and 0.9  $\mu\text{m}$  wavelength regions. Broad bands at these wavelengths frequently occur in high iron content soils; while a sharp, narrow absorption band at 0.9  $\mu\text{m}$  is evident in many soils of relatively low or even negligible iron content.

Different forms of iron oxides are known to impart red and yellow colors to soils. Reflectance data in this atlas indicate that near infra-red absorption may be partly responsible for coloring in high iron content soils.

#### Moisture Percentage by Weight (MW%)

Soil moisture content by weight was determined gravimetrically on the soil samples used to obtain reflectance measurements. All soil samples were equilibrated at a one-tenth bar moisture tension, so resulting moisture differences are closely related to clay type, soil texture, and organic matter content. All other properties being equal, an increase in soil moisture content decreases soil reflectance at all wavelengths.

Strong water absorption bands at 1.45 and 1.95  $\mu\text{m}$  are present in all of the spectral curves of these uniformly-moist soils. Weak water absorption bands at 1.2 and 1.77  $\mu\text{m}$  are seen in some low organic content fine sandy soils. Actual soil moisture content has been seen to be most highly correlated with soil reflectance in the 2.08-2.32  $\mu\text{m}$  region.

#### Plot of Bidirectional Reflectance Factor (BRF%) Versus Wavelength ( $\mu\text{m}$ )

A convenient standard measure of reflectance that closely simulates the directional characteristics of illumination and viewing in an airborne remote sensor is the bidirectional reflectance factor. Bidirectional reflectance factor can be described as the ratio of the flux reflected by an object under specified conditions of negligibly small solid angles of irradiation and viewing to that reflected by the ideal, completely reflecting, perfectly diffusing surface, identically irradiated and viewed (18).

Wavelength, expressed in micrometer ( $\mu\text{m}$ ) units, denotes the portion of the electromagnetic spectrum under consideration. Wavelength regions frequently referred to are the visible (0.38-0.72  $\mu\text{m}$ ), near infrared (0.72-1.3  $\mu\text{m}$ ), and middle infrared (1.3-3.0  $\mu\text{m}$ ).

## 5. Numerical Analysis

### 5.1 Statistical Correlation Studies

For the purpose of statistical correlation all soil spectral curves were represented by ten spectral bands (Table D-1). Bands 1-8 all have bandwidths of 0.1  $\mu\text{m}$ . Bands 1 and 2 are visible bands. Bands 2 and 4 are centered on the regions of known ferric iron absorption. Most of bands 1-8 resemble, but may not coincide exactly with existing bands on Landsat or Skylab S192. Bands 9 and 10 are proposed Thematic Mapper bands with band 10 being slightly altered by the cutoff of spectroradiometric data at 2.32  $\mu\text{m}$ .

Table D-1. Soil Spectral Bands for Correlation Analysis.

Band	Wavelength ( $\mu\text{m}$ )	Spectral Region	Band	Wavelength ( $\mu\text{m}$ )	Spectral Region
1	0.52-0.62	visible	6	1.02-1.12	near IR
2	0.62-0.72	visible	7	1.12-1.22	near IR
3	0.72-0.82	near IR	8	1.22-1.32	near IR
4	0.82-0.92	near IR	9	1.55-1.75	middle IR
5	0.92-1.02	near IR	10	2.08-2.32	middle IR

Statistical correlations between five soil parameters and reflectance in these individual bands is listed for various groupings of soils (Tables D-2 and D-3). Correlations are seen to improve with more specific climatic grouping of soil data. The 95% confidence intervals on the correlation coefficient give an idea of the range of correlation values that can be expected based on the number of soils in each climatic grouping.

Table D-2. Simple correlation coefficients between five soil parameters and reflectance in individual bands for all soils and for soils grouped by moisture zone and by temperature regime.

r values for most highly correlated band (parentheses) with 95% confidence intervals on r

climatic grouping no. of soils in class	$\log_e(O.M.)$	soil parameter			
		moisture percentage by weight	particle size distribution	cation exchange capacity	iron oxide content
<u>all soils</u> 481	-.68(2) -.73<r<-.63	-.53(10) -.59<r<-.46	clay -.41(10) -.48<r<-.33	-.48(10) -.55<r<-.41	-.16(10) -.25<r<-.07
<u>moisture zone</u>			clay		
<u>humid</u> 185	-.68(1) -.72<r<-.64	-.47(10) -.53<r<-.41	-.25(10) -.32<r<-.18	-.50(1) -.55<r<-.44	.18(2) .11<r<.25
subhumid 128	-.78(6) -.81<r<-.74	-.78(10) -.81<r<-.74	clay -.61(10) -.66<r<-.55	-.71(10) -.75<r<-.66	-.16(10) -.25<r<-.07
semiarid 94	-.53(3) -.60<r<-.45	-.39(10) -.48<r<-.30	fine sand .47(10) .38<r<.55	-.22(10) -.31<r<-.11	-.55(8) -.62<r<-.47
arid 62	-.73(2) -.78<r<-.66	-.71(2) -.77<r<-.64	fine sand .68(2) .60<r<.74	-.37(10) -.47<r<-.25	-.28(1) -.40<r<-.16
<u>temperature regime</u>			clay		
<u>frigid</u> 102	-.43(1) -.54<r<-.34	-.41(10) -.49<r<-.32	-.40(10) -.47<r<-.31	-.47(10) -.54<r<-.38	.40(3) .31<r<.48
mesic 211	-.68(1) -.71<r<-.64	-.48(10) -.53<r<-.42	clay -.27(10) -.33<r<-.20	-.52(10) -.57<r<-.47	.08(4) .01<r<.15
thermic 140	-.64(6) -.69<r<-.59	-.68(10) -.72<r<-.63	clay -.57(10) -.61<r<-.51	-.48(10) -.54<r<-.41	-.19(10) -.27<r<-.10
hyperthermic 28	-.75(3) -.82<r<-.65	-.75(8) -.82<r<-.65	fine silt -.68(8) -.77<r<-.56	-.65(8) -.75<r<-.52	-.23(10) -.40<r<-.03



Table D-3. Simple correlation coefficients between five soil parameters and reflectance in individual bands by climatic zone.

r values for most highly correlated bands (parentheses) with 95% confidence intervals on r

climatic subgroup no. of soils in class	$\log_e(0.M.)$	soil parameter			
		moisture percentage by weight	particle size distribution	cation exchange capacity	iron oxide content
humid frigid 38	-.66(10) -.74<r<-.55	-.43(1) -.55<r<-.28	fine sand	-.45(1) -.57<r<-.31	.56(2) .43<r<.66
			.37(10) .22<r<.51		
humid mesic 75	-.66(1) -.72<r<-.59	-.29(10) -.39<r<-.18	fine silt	-.73(1) -.78<r<-.67	.30(2) .19<r<.40
			.58(9) .50<r<.65		
humid thermic 60	-.71(8) -.77<r<-.64	-.65(10) -.72<r<-.56	clay	-.73(9) -.79<r<-.66	-.18(10) -.30<r<-.05
			-.53(10) -.62<r<-.43		
subhumid frigid 42	-.77(4) -.83<r<-.70	-.75(10) -.81<r<-.67	clay	-.86(9) -.90<r<-.81	-.20(10) -.35<r<-.04
			-.67(9) -.75<r<-.57		
subhumid mesic 46	-.81(6) -.89<r<-.75	-.64(10) -.72<r<-.54	clay	-.71(10) -.78<r<-.63	.52(2) .40<r<.62
			-.63(10) -.71<r<-.53		
subhumid thermic 36	-.62(2) -.72<r<-.50	-.82(10) -.87<r<-.75	sand	-.63(10) -.72<r<-.51	-.44(6) -.57<r<-.29
			.76(2) .68<r<.82		
semiarid frigid 18	-.28(1) -.50<r<-.03	-.48(10) -.65<r<-.26	clay	-.60(10) -.74<r<-.41	.26(2) 0<r<.48
			-.67(10) -.79<r<-.50		
semiarid mesic 46	-.32(2) -.45<r<-.18	-.34(10) -.47<r<-.20	very fine sand	-.44(1) -.56<r<-.31	-.42(9) -.54<r<-.29
			.43(2) .30<r<.55		
semiarid thermic 20	-.58(3) -.72<r<-.40	-.55(10) -.70<r<-.36	medium sand	-.40(3) -.58<r<-.18	-.67(9) -.78<r<-.51
			.66(10) .50<r<.78		
arid mesic 32	-.79(3) -.85<r<-.71	-.79(3) -.85<r<-.71	clay	-.73(4) -.80<r<-.63	.39(4) .22<r<.54
			-.62(3) -.72<r<-.49		
arid thermic 24	-.67(2) -.77<r<-.53	-.75(10) -.83<r<-.63	fine sand	-.47(10) -.62<r<-.28	-.73(9) -.82<r<-.61
			.90(4) .85<r<.93		

Reflectance in all of the spectral bands is seen to be negatively correlated with the natural logarithmic transformation of organic matter content. Reflectance in the important 2.08-2.32  $\mu\text{m}$  band is negatively correlated, in addition, to moisture content, cation exchange capacity, iron oxide content and clay content, while it is positively correlated with medium and fine sand contents.

## 5.2 Prediction Models

A forward stepwise inclusion procedure was used to estimate the reflectance in individual wavelength bands using certain agronomic and site characteristics as predictors. The importance of climatic zone, parent material, and drainage characteristics in explaining soil reflectance was brought out in this analysis (Table D-4). Other soil parameters had an expected influence on reflectance, with organic matter being the single most important variable in all but band 10, where moisture content was the first variable to be included in the regression equation. Although the  $R^2$  values were not high for this analysis of 481 soils, the inclusion of site characteristics pointed to the importance of these soil-forming factors as contributors to soil reflectance.

Prediction models for certain soil parameters using only soil reflectance data as inputs reveal high  $R^2$  values when soils are grouped by specific climatic zone (Table D-5). The importance of visible, near infrared, and middle infrared reflectance data is seen repeatedly. Iron oxide has high predictive values only in the humid frigid and some arid regions. Results are highly climate specific. As in previous studies of this type, cation exchange capacity often shows higher  $R^2$  values than other soil parameters which are known to exhibit inherent spectral behavior. Cation exchange capacity seems to be acting as a natural integrating factor for several other soil parameters such as organic matter and particle size.

Extending these results to the level of airborne remote sensors, it is likely that reflectance data from carefully selected wavelength bands could be used to extract information from bare soil areas that could be related to levels of organic matter, soil moisture, iron oxide content,



Table D-5. Soil reflectances in individual bands as predictors of soil parameters within certain climatic zones.

R<sup>2</sup> values and spectral bands entered into regression equations

climatic subgroup no. of soils in class	log <sub>e</sub> (O.M.)	soil parameter			
		moisture percentage by weight	particle size distribution	cation exchange capacity	iron oxide content
humid frigid 38	.78 10,9,2,8,4,1	.95 1,6,10,3,8	clay .54 10,2,1,3,4,8	.84 1,8,10,4	.67 2,10,5,9,8,4,1
humid mesic 75	.61 1,10,3,5,9	.32 10,8,9,5,2,1	fine silt .48 9,1,4,10	.65 1,10,9,8,4	.21 2,1,4,8,5,10
humid thermic 60	.53 8,10,2,4	.54 10,2,3,7,1	clay .30 10,9	.65 9,2,3,6,10,1	.49 10,2,1,4,8,5,9
subhumid frigid 42	.66 4,9,6,1,10	.60 10,9,8	clay .51 9,6,4,2,10	.75 9,7	.23 10,2,1,3,7,6,9
subhumid mesic 46	.70 6,10,1,3,	.52 10,5	clay .73 10,9,7,3	.72 10,1,6,9,4	.51 2,1,4,8,3,9,5,10
subhumid thermic 36	.73 2,3,5,9,10,1	.87 10,2,9,8,4,1	clay .69 5,1,7,10,9	.77 10,9,8,3	.51 6,2,7,1,3,8,10,9
semiarid frigid 18	.67 1,5,10,4,8	.77 10,8,3,9,2,1	clay .90 10,9,4,2,6,1	.74 10,8,4,2,9,1	.37 2,1,3,9,5,4,10,8
semiarid mesic 46	.40 2,8,4,9	.64 10,9,1,4	clay .49 10,9,1,3	.57 1,3,6,10,9	.38 9,1,6,8,5,2,3,10
semiarid thermic 20	.59 3,1,9	.68 10,3,1,8	clay .65 3,1,10,9	.74 3,1,10,9	.68 9,10,7,5,1,2
arid mesic 32	.68 3,1,10,5	.75 3,1,10,9	clay .80 3,1,8,10	.73 4,1,8,10	.40 4,1,9,7,3,10
arid thermic 24	.60 2,4,1	.76 10,9,3,8	fine sand .83 4,10,9,8	.60 10,9,1,8,4	.70 9,10,7,1,6,4,3

particle size content, or even an indicator of potential productivity such as cation exchange capacity for certain specified climatic areas. Where prior information is available about soil drainage and parent material classes, even better correlations can be expected within more homogeneous areas of soil inference.

### 5.3 Discussion of Results

Based on results of statistical analyses as well as on qualitative evaluation of soil reflectance/absorption characteristics, the following wavelengths are critical for identification of soil reflectance characteristics: 0.52 to 0.62  $\mu\text{m}$  (green wavelength region highly correlated with organic matter content), 0.7  $\mu\text{m}$  and 0.9  $\mu\text{m}$  (ferric iron absorption wavelengths), 1.0  $\mu\text{m}$  (ferrous iron and hydroxyl gibbsite absorption wavelength), 1.22 to 1.32  $\mu\text{m}$  and 1.55 to 1.75  $\mu\text{m}$  (regions of highest reflectance for many soils, correlated with many soil properties), 2.08 to 2.32  $\mu\text{m}$  (region of highest correlations with soil moisture). Although spectral bands for the Thematic Mapper sensor include 0.52 to 0.60  $\mu\text{m}$ , 1.55 to 1.75  $\mu\text{m}$  and 2.08 to 2.35  $\mu\text{m}$ , the 0.76 to 0.90  $\mu\text{m}$  near infrared wavelength band is too broad for specific iron oxide studies in soils, a fact that could limit its usefulness in erosion studies as well as soil productivity surveys.

It can be seen that soils with widely-differing physicochemical and site characteristics are no more similar in their reflectance properties than are different species of plants throughout their growth cycles. To treat soil reflectance as a constant, unchanging characteristic from location and from date to date is to ignore the well-ordered physical and chemical relationships that impart diverse spectral reflective character to soils. The soils data base developed in this study should help further an understanding of the diverse nature of soils as they would be viewed by remote sensors.

## 6. References

1. Bauer, M. E., et al., "Agricultural Scene Understanding," LARS Contract Report 112578, Laboratory for Applications of Remote Sensing, Purdue University, West Lafayette, Indiana, November 1978.
2. Stoner, E. R., "Physicochemical, Site, and Bidirectional Reflectance Factor Characteristics of Uniformly-Moist Soils," Ph.D. Thesis, Purdue University, West Lafayette, Indiana. Also published as LARS Technical Report 111679, November 1979.
3. Stoner, E. R., M. F. Baumgardner, L. L. Biehl, and B. F. Robinson, "Atlas of Soil Reflectance Properties," LARS Technical Report 111579, Laboratory for Applications of Remote Sensing, Purdue University, West Lafayette, Indiana, November 1979.
4. Bowers, S. A. and R. J. Hanks, "Reflectance of Radiant Energy of Soils," *Soil Sci.* 100:130-138, 1965.
5. Cipra, J. E., M. F. Baumgardner, E. R. Stoner, and R. B. MacDonald, "Measuring Radiance Characteristics of Soil with a Field Spectroradiometer," *Soil Sci. Soc. Amer. Proc.* 35:1014-1017, 1971.
6. Condit, H. R., "The Spectral Reflectance of American Soils," *Photogrammetric Eng.* 36:955-966, 1970.
7. Montgomery, O. L., "An Investigation of the Relationship Between Spectral Reflectance and the Chemical, Physical and Genetic Characteristics of Soils," Ph.D. Thesis, Purdue University, West Lafayette, Indiana. Also published as LARS Technical Report 082776, August 1976.
8. Soil Survey Staff, "Soil Taxonomy--a Basic System of Soil Classification for Making and Interpreting Soil Survey," Soil Conservation Service, U.S. Dept. of Agric., Agriculture Handbook No. 436, Washington, D.C., 1975.
9. Smith, Guy D., Ranklin Newhall and Luther H. Robinson, "Soil Temperature Regimes, Their Characteristics and Predictability," SCS-TP-144. Soil Conservation Service, U.S. Dept. of Agric., Washington, D.C., 1964.
10. FAO-UNESCO, "Soil Map of the World, Vol II: North America," United Nations Educational, Scientific, and Cultural Organization, Paris, 1975.
11. Thornthwaite, C. W., "An Approach toward a Rational Classification of Climate," *Geograph. Rev.* 38:55-94, 1948.
12. Fasolo, P. J., "Mineralogical Identification of Four Igneous Extrusive Rock Derived Soils from the State of Paraná, Brazil," M.S. Thesis, Purdue University, West Lafayette, Indiana, 1978.
13. Silva, L. F., R. M. Hoffer, and J. E. Cipra, "Extended Wavelength Field Spectroradiometry," *Proc. 7th International Symposium on Remote Sensing of Environment*, Ann Arbor, Michigan, pp. 1509-1518, 1971.

14. Leamer, R. W., V. I. Meyers, and L. F. Silva, "A Spectroradiometer for Field Use," Rev. Sci. Instrum. 44:611-614, 1973.
15. DeWitt, D. P. and B. F. Robinson, "Description and Evaluation of a Bidirectional Reflectance Factor Reflectometer," Technical Report 091576, Laboratory for Applications of Remote Sensing, Purdue University, West Lafayette, Indiana, September 1976.
16. Simmons, W. R., S. Wilkinson, W. C. Zurney, and J. L. Kast, "LARSPEC: Analysis Program for EXOTECH Model 20C Model 20C Data," LARS Program Abstract 5000, Laboratory for Applications of Remote Sensing, Purdue University, West Lafayette, Indiana, 1975.
17. SCS-USDA, "Soil Survey Laboratory Methods and Procedures for Collecting Soil Samples," Soil Survey Investigations Report No. 1., U.S. Govt. Printing Office, Washington, D.C., 1972.
18. Nicodemus, F. E., J. C. Richmond, J. J. Hsia, I. W. Ginsberg, and T. Limperis, "Geometrical Considerations and Nomenclature for Reflectance," National Bureau of Standards Monograph 160, U.S. Govt. Printing Office, Washington, D.C., 1977.

E. FIELD RESEARCH DATA BASE MANAGEMENT AND SOFTWARE DEVELOPMENT\*

Larry L. Biehl

The development of the field research data library at Purdue/LARS was initiated in the fall of 1974 by NASA/Johnson Space Center (JSC) with the cooperation of the United States Department of Agriculture (USDA) as a part of the Large Area Crop Inventory Experiment (LACIE). The purpose of the data base is to provide fully annotated and calibrated multitemporal sets of spectral, agronomic, and meteorological data for agricultural remote sensing research. Spectral, agronomic, and meteorological measurements were made over primarily wheat on three LACIE test sites in Kansas, North Dakota, and South Dakota for the first three years. During the past two years, the data library has been expanded to include data collected for corn and soybean experiments in Indiana, Iowa, and Nebraska, as well as from a major U.S. soils experiment.

Milestones achieved during the past year have been:

- Data library and distribution
  - Inclusion of 1978 crop year data
  - Inclusion of part of 1979 crop year data
  - Inclusion of 1978 soils data
  - Distribution of data to researchers
  - Update of field research data library catalog
  - Preparation of report on the evaluation of spectral data calibration procedures.
- Development and documentation of analysis software
- Development and documentation of processing software

The report on the evaluation of spectral data calibration procedures is given in section F.

---

\*This section describes the results of Task 3B, Field Research Data Base Management and Distribution, along with software development and documentation which were performed in part under Tasks 1A and 1B. The contributions of Cathy Koziowski and Don McLaughlin to data processing software development and data preparation; of Nancy Fuhs, Jeanne Etheridge, Jerry Majkowski, and Jill Heinrich to data analysis software development and documentation; and of Donna Scholz, Jo Albert, Bev Carpenter, and Gay Benson to data base management are gratefully acknowledged.



## 1. Field Research Data Library and Distribution

The general organization of the field research data library is illustrated in Figure E-1. The data in the library includes spectral measurements, agronomic measurements, meteorological measurements, photography, mission logs, and data verification reports. The data formats available to researchers are digital tape, film, and data listings.

The data have been collected over several test sites and for different crops as illustrated in Table E-1. The test sites are of two types, controlled experimental plots and commercial fields. Table E-2 presents a summary of the experimental plot and commercial field test site locations.

The instruments used to collect the spectral data are listed in Table E-3. The spectrometer data are processed into comparable units, bidirectional reflectance factor, in order to make meaningful comparisons of the data acquired by the different sensors at different times and locations. The use of this approach is evaluated in section F. The spectrometer data tapes contain the spectral bidirectional reflectance factor measurements along with most of the corresponding agronomic and meteorological measurements. The data is stored in Purdue/LARS spectrometer/radiometer data storage tape format.

The multispectral scanner data are approximately linearly related to scene radiance. The information is available for the researcher to calibrate the scanner data to in-band bidirectional reflectance factor if desired. Most of the scanner data are stored in LARSYS Version 3 format; some data are available in universal format.

A summary of the spectral data in the data library is given in Table E-4. In the past twelve months, five aircraft scanner runs and 18,000 spectrometer/radiometer observations for the 1978 crop year have been made available to researchers. The 1978 data includes spectral observations of over 500 soil samples from 39 states of the United States as well as Brazil, Costa Rica, Sudan, Spain, and Jordan along with their

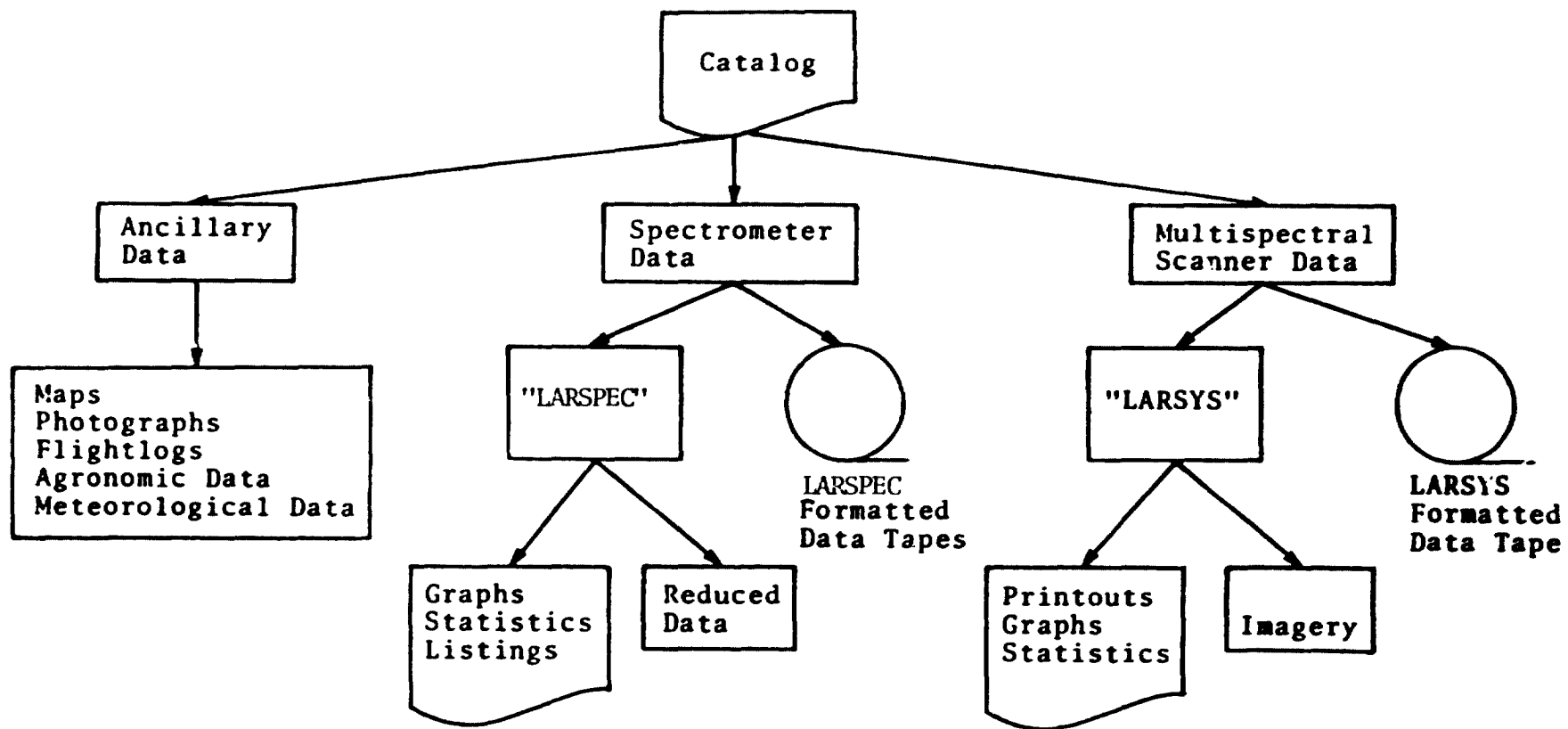

Figure E-1. Organization of field research data library. LARSPEC and LARSYS are Purdue/LARS software systems to analyze spectrometer/radiometer and multispectral scanner data.

Table E-1. Summary of field research test site locations and major crops.

Crop Year	Finney Co. Kansas	Williams Co. N. Dakota	Hand Co. S. Dakota	Tippecanoe Co. Indiana	Webster Co. Iowa	McPhearson Co. Nebraska
1975	Winter Wheat	Spring Wheat	-	-	-	-
1976	Winter Wheat	Spring Wheat	Spring & Winter Wheat	-	-	-
1977	Winter Wheat	Spring Wheat	Spring & Winter Wheat	-	-	-
1978	-	-	Spring & Winter Wheat	Corn Soybeans	-	-
1979	-	-	Spring & Winter Wheat	Corn Soybeans Winter Wheat	Corn Soybeans	Corn

Table E-2. Summary of field research controlled experimental plot test sites and commercial field test sites.

Location	Crop Years
<b>Controlled Experimental Plot Test Sites</b>	
Kansas State University Agriculture Experiment Station, Garden City, Kansas	1975-77
North Dakota State University Agriculture Experiment Station, Williston, North Dakota	1975-77
Purdue University Agronomy Farm, West Lafayette, Indiana	1978-79
University of Nebraska Agriculture Experiment Station, Sandhills, Nebraska	1979
<b>Commercial Field Test Sites</b>	
Finney County, Kansas	1975-77
Williams County, North Dakota	1975-77
Hand County, South Dakota	1976-79
Webster County, Iowa	1979

Table E-3. Summary of major sensor systems used for field research.

---

Platform and Sensor

---

Spacecraft Multispectral Scanners

Landsat 1  
Landsat 2  
Landsat 3

Aircraft Multispectral Scanners

24-channel Scanner (MSS)  
11-channel Modular Multispectral Scanner (MMS)

Helicopter-mounted Spectrometer

NASA/JSC Field Spectrometer System (FSS)

Truck-mounted Spectrometers

NASA/ERL Exotech 20D Field System  
NASA/JSC Field Signature Acquisition System (FSAS)  
Purdue/LARS Exotech 20C Field System

Truck-mounted Multiband Radiometers

Purdue/LARS Exotech 100 Landsat Band Radiometer Field System

---

Table E-4. Summary and Status of Spectral Data in the field research data library by instrument and data type.

Instrument/Data Type	Crop Year(s) and Status		
	1975-1978	1979	
	Complete	Complete	In Processing
Landsat MSS			
Whole Frame CCT (Frames)	124	---	---
Aircraft Multispectral Scanner			
(Dates/Flightlines)	46/301	1/5	5/
Helicopter Mounted Field Spectrometer			
(Dates/Observations)			
Field Averages	74/6870	---	17/
Individual Scans	74/114,829	---	17/
Truck Mounted Field Spectrometer/ Multiband Radiometer			
(Dates/Observations)			
NASA/JSC FSAS	45/813	---	---
Purdue/LARS Exotech 20C	99/7055	18/716	5/134
NASA/ERL Exotech 20D	45/645	---	---
Purdue/LARS Exotech 100	32/6077	16/3120	9/5097

physical and chemical properties. This data set is described in section D. Also 4000 spectrometer/radiometer observations for the 1979 crop year have been processed and made available to researchers.

Four institutions have received or accessed field research data during the past year. In addition all the data are routinely available to researchers at Purdue/LARS. Also, investigators at NASA/Johnson Space Center and the Environmental Research Institute of Michigan have direct access to the digital data via remote terminals to the LARS' computer. Table E-5 summarizes the data that have been distributed during the past three years and indicates which institutions received data during this past year.

The Field Research Data Library Catalog summarizes the data available. The catalog includes a separate volume for each crop year during which data were collected. The volumes for the 1978 and 1979 crop years have slightly different formats than the volumes for the 1975-1977 crop years. The instrument indices for the spectrometer data contain much more information including experiment summaries, solar zenith angles, and cloud cover summaries to help researchers determine which data meet their needs. The 1975-1977 crop year volumes are being converted to the new format.

Table E-5. Summary of recipients of field research data.

Organization/Data Provided	Number of Requests
NASA/Goddard Space Flight Center Greenbelt, Maryland	>5/
Spectrometer Data - 50 dates/45,000 observations	
Aircraft Photography	
Landsat segments and color composites - 8	
Helicopter and ground photography	
Field maps	
Agronomic and meteorological measurements	
(Also access to data through Purdue/LARS remote terminal)	
General Electric Corporation Philadelphia, Pennsylvania	2
Spectrometer data - 21 dates/15,000 observations	
Landsat frames and color composites - 7	
Agronomic and meteorological measurements	
Field maps	
Aircraft and ground photography	
University of South Florida Tampa, Florida	1
Spectrometer data - 27 dates/2600 observations	
Agronomic and meteorological measurements	
USDA, Agriculture Research Service Weslaco, Texas	1
Spectrometer data - 2 dates/3500 observations	
Agronomic and meteorological measurements	
Field maps	
Goddard Institute for Space Studies New York, New York	3/
Spectrometer data - 51 dates/24,000 observations	
Aircraft scanner data - 4 dates/12 flightlines	
Agronomic and meteorological measurements	
Field maps	



Table E-5. Summary of recipients of field research data (cont).

Organization/Data Provided	Number of Requests
Ecosystems, Inc. Gambrills, Maryland  Spectrometer data - 13 dates/805 observations Agronomic and meteorological measurements	*✓
Environmental Research Institute of Michigan Ann Arbor, Michigan  Access to data through Purdue/LARS remote terminal	+✓
NASA, Johnson Space Center Houston, Texas  Access to data through Purdue/LARS remote terminal	+
Purdue University, Laboratory for Applications of Remote Sensing West Lafayette, Indiana  Location of field research data library	+

\* Received from NASA/Goddard Space Center.

+ SR&T users of field research data.

✓ Recipients of field research data during 1979.

## 2. Data Analysis Software Development and Documentation

During the field research project over the past five years, over 140,000 observations of calibrated spectrometer data and 300 flight lines of aircraft scanner data have been collected. Researchers require more powerful research tools to analyze the data efficiently and effectively. During this past year several analysis software tools were developed and/or documented. The achievements include:

- Expansion and Documentation of LARSPEC
- Implementation of Statistical Analysis System (SAS)
- Implementation of 3-dimensional graphics software

### 2.1 Expansion and Documentation of LARSPEC

A new name was selected for the software system on the Purdue/LARS computer which accesses the spectrometer/radiometer data and associated agronomic and meteorological measurements. The new name is LARSPEC which replaces the name EXOSYS. Major capabilities which were added to LARSPEC this year are: (1) ability to access multiband radiometer data, such as data from the Exotech 100 Landsat band radiometer, (2) increased ability to transfer agronomic data to disk for use by the SAS or SPSS statistical routines, (3) addition of crop productivity parameters to identification records. A concentrated effort is being made to adequately document these new capabilities for researchers.

The original documentation for LARSPEC, formerly called EXOSYS, was written in 1974. Since then several new capabilities have been added to the processors, outdated the pre-existing documentation. With the addition of new graphics and clustering capabilities in 1978, the decision was made to develop a new LARSPEC User's Manual containing a control card dictionary, examples of inputs and outputs, and error messages. The manual should enhance the usefulness of the LARSPEC software system for field research data analysis. Since LARSPEC is a dynamic software system, the LARSPEC User's Manual will continue to be revised as new capabilities are added. The Table of Contents for the LARSPEC User's Manual is given in Figure E-2. In the next few months additional documentation, The LARSPEC Training Manual, will be developed.

## 2.2 Implementation of Statistical Analysis System (SAS)

The Statistical Analysis System (SAS) was implemented on the computer late this year to increase statistical analysis capabilities. SAS augments other statistical analysis routines, such as SPSS, which are already available on the LARS' computer. SAS is available on a trial basis to determine its usefulness. The capabilities of SAS include a wide range of statistical procedures including general linear models, multivariate analysis of variance, and a variety of linear and nonlinear regression methods. SAS also includes report writing capabilities, data management tools, and line printer plot and chart routines.

## 2.3 Implementation of 3-Dimensional Graphics Software

During this past year, a set of 3-dimensional graphics software routines were implemented on the LARS' computer. The software is the 3-D Graphics Compatibility System (GCS) acquired from the U. S. Army Corps of Engineers at the Waterways Experiment Station, Vicksburg, Mississippi. The software routines, in Fortran, can be used in the development of researcher tools for more complex displays and analyses of spectral-agronomic data. The software has the capability for plotting 3-D graphics in perspective or orthographic projections for 3-D rectangular, spherical, or cylindrical coordinate systems. The axes may be in linear or logarithmic units. Examples are given in Figures E-3 and E-4. The user may 'walk' around, over or under the graph or object by defining the view point and site point with six numbers.

Documentation for the 3-D GCS system has recently been distributed to researchers at Purdue/LARS, NASA/Johnson Space Center, and the Environmental Research Institute of Michigan. Also, a high resolution graphics terminal has been ordered. The new terminal, a Tektronix model 4054, is expected to be received and made available for researcher's use during the first six months of 1980. The graphics terminal will be a valuable tool for data verification and data analysis.

### 3. Data Processing Software Development

Two major processing software capabilities were developed and documented this year. The first is the software to process the Exotech 100 Landsat band radiometer data and the second is software to update spectrometer identification records. The Exotech 100 processing software, or more correctly, the multiband radiometer data processing software is described in section C.

The software to update LARSPEC identification records provides the capability to process the Exotech 20C and Exotech 100 spectral data soon after it is collected prior to having all the agronomic measurements. The agronomic data can be added to the identification records later when they become available. Previously the data, spectral and agronomic, had to be reprocessed completely to add new information. This capability is the reason that a large part of the 1979 Purdue Agronomy farm data is available for analysis before the end of the year.

LARSPEC USER'S MANUAL

Table of Contents

1. LARSPEC Processing Functions
  2. Procedures for Using LARSPEC
    - 2.1 Batch Mode
    - 2.2 Interactive Mode Via Control Cards from Disk File
    - 2.3 Interactive Mode Via Control Cards from Card Reader
    - 2.4 Interactive Mode Via Control Cards from Terminal
  3. Control Card Dictionary
    - 3.1 Terminal Commands
    - 3.2 Monitor Control Cards
    - 3.3 DSEL Processor Control Cards
    - 3.4 GSPEC Processor Control Cards
    - 3.5 IDLIST Processor Control Cards
  4. Discussion of Processor Function Input and Output
    - 4.1 Data Selection Processor (DSEL)
    - 4.2 Data Graph Processor (GSPEC)
    - 4.3 Identification Record List Processor (IDLIST)
  5. LARSPEC Error Messages
- Appendix A. Abbreviated Control Card Listing
- Appendix B. LARS Field Spectrometer/Radiometer Data Storage Tape Format
- Appendix C. Description of Data Tape Utility Processor

Figure E-2. Table of contents of LARSPEC User's Manual.

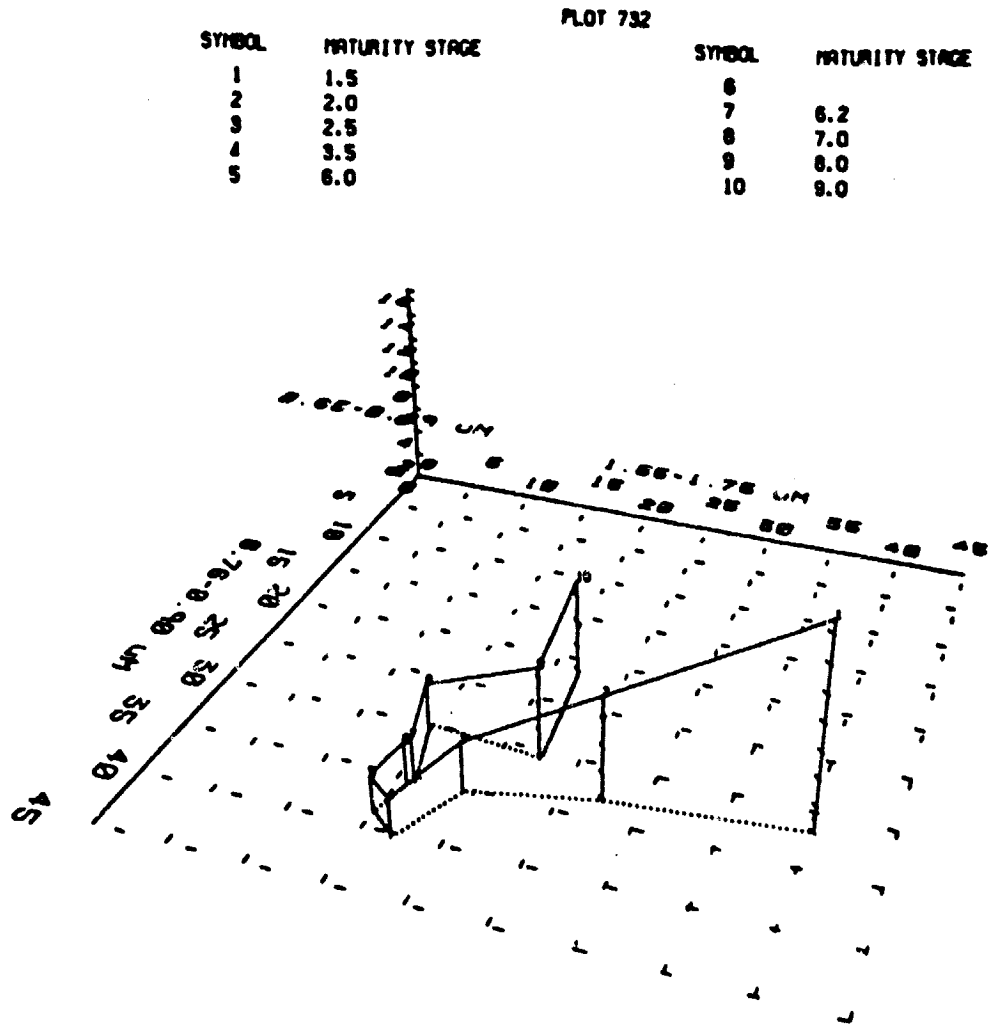

Figure E-3. Example of 3-dimensional line type plot using 3-D Graphics Compatibility System software. This plot is a temporal (growth stage) plot of three Thematic Mapper bands for corn.

JOINT DENSITY FUNCTION PLOT

CLASS	CLASS NAME	CLASS	CLASS NAME
4	EXTARTI	9	DECID
5	SOIL	11	RIVER
7	VEGION	13	LAKE2

View Point 240, 240, .11  
Site Point 24, 24, 0  
Window -120, 120, -.11, .11

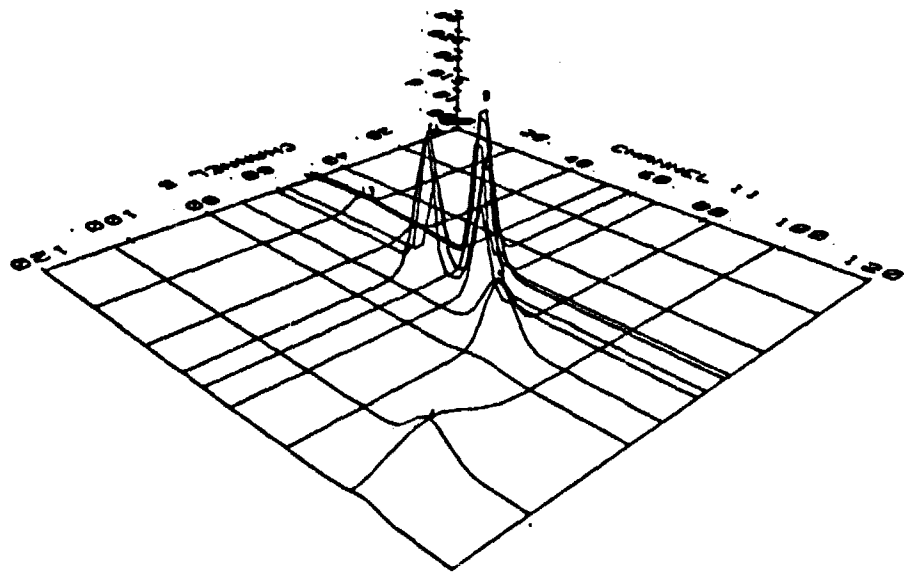

Figure E-4. Example of 3-dimensional surface type plot using 3-D Graphics Compatibility System software. This plot represents the joint density function for two channels and six classes in a LARSYS statistics deck for Skylab data.

F. EVALUATION OF CALIBRATION PROCEDURES FOR MEASUREMENT OF BIDIRECTIONAL REFLECTANCE FACTOR IN REMOTE SENSING FIELD RESEARCH\*

Barrett F. Robinson and Larry L. Biehl

1. Introduction

The use of measurements of optical radiation for identification and area estimation of agricultural crops from earth satellites has reached near operational status for some crops (1,2). As the technology develops there is growing awareness of the need for quantitatively understanding the optical properties of crops and soils.

Researchers are heading to the fields in increasing numbers with a variety of instruments to measure radiation reflected and emitted by soils and crop canopies. While many types of measurements will prove to be useful, there is a need for data which may be compared from site to site and instrument to instrument, independent of atmospheric conditions.

This section describes and evaluates a reflectance calibration procedure which has been used since 1974 by Purdue/LARS and NASA/JSC in the field research project sponsored by NASA/JSC to obtain field measurements which are being analyzed across sites, instruments, and dates in ongoing agricultural experiments (3).

2. Bidirectional Reflectance Factor (BRF)

A reflectance factor is defined as the ratio of the radiant flux actually reflected by a sample surface to that which would be reflected into the same reflected beam geometry by an ideal (lossless) perfectly

---

\* This section describes work performed under Tasks 1B and 3B. The contributions of Professors David P. DeWitt and LeRoy F. Silva of Purdue University and Dr. David E. Pitts and Mr. Richard Juday of NASA/Johnson Space Center are gratefully acknowledged.



diffuse (Lambertian) standard surface irradiated in exactly the same way as the sample (4).

The essential field calibration procedure consists of the comparison of the response of the instrument viewing the subject to the response of the instrument viewing a level reference surface. For small fields of view (less than  $20^\circ$  full angle) the term bidirectional reflectance factor has been used to describe the measurement: one direction being associated with the viewing angle (usually  $0^\circ$  from normal) and the other direction being the solar zenith and azimuth angles.

The true bidirectional reflectance factor  $R(\theta_i, \phi_i; \theta_r, \phi_r)$  is defined for incident and reflected beams where  $(\theta_i, \phi_i)$  and  $(\theta_r, \phi_r)$  are the zenith and azimuth angles of the incident beam and reflected beam, respectively (4).

The essential field calibration procedure consists of the measurement of the response,  $V_s$ , of the instrument viewing the subject and measurement of the response,  $V_r$ , of the instrument viewing a level reference surface to produce an approximation to the bidirectional reflectance factor of the subject.

$$R_s(\theta_i, \phi_i; \theta_r, \phi_r) = \frac{V_s}{V_r} R_r(\theta_i, \phi_i; \theta_r, \phi_r) \quad (1)$$

where  $R_r(\theta_i, \phi_i; \theta_r, \phi_r)$  is the bidirectional reflectance factor of the reference surface.  $R_r$  is required to correct for the non-ideal reflectance properties of the reference surface.

The assumptions in the procedure are:

- (1) The incident radiation is dominated by its directional component; this is discussed below.
- (2) The instrument responds linearly to entrant flux.
- (3) The reference surface is viewed in the same manner as the subject and the conditions of illumination are the same.
- (4) The entrance aperture is sufficiently distant from the subject and the angular field of view is small with respect to the

hemisphere of reflected beams. For our purposes a  $20^\circ$  angular field of view is about the limit for this assumption.

- (5) The reflectance properties of the reference surface are known; this is discussed below.

For multiband radiometers the reflectance factor results from the response of the instrument to the radiance of the subject and the reference in each effective passband and, therefore, is an in-band reflectance. For spectroradiometers the spectral bidirectional reflectance factor is computed at each resolved wavelength.

### 3. Discussion of the Approach

The objective of the approach is to obtain a property of the scene which is nearly independent of the incident irradiation and atmospheric conditions at the time of the measurement. The majority of measurements are made by viewing along the normal to the subject and the level reference surface with solar angles similar to those for satellite overpasses. Under these conditions, the properties of the subject are measured which affect the response of a satellite-borne sensor.

If the researcher desires, the irradiance and directional radiance of the subject may be determined from the raw data, provided the instrument is calibrated. However, the estimation of these quantities usually involves a high degree of uncertainty. Fortunately, it is not necessary to know them to compute the reflectance factor.

An understanding of the factors which affect the bidirectional reflectance factor of agricultural scenes will provide a basis for improved identification and characterization of agricultural crops. A deeper understanding will be required in the future with the advent of improvements in characterizing the optical properties of the atmosphere over frames of satellite-borne sensor data and future satellite sensors which may view the surface at angles significantly different from normal.

#### 4. Field Procedures

The field procedure for reflectance factor calibration will vary with the instrument system depending mainly on the means used to support the instrument above the crop. The principle is, as nearly as possible, to measure the level reference surface with the same conditions of irradiation and viewing as the crop was measured. For example, Figure F-1 shows a multiband radiometer mounted on a pick-up truck mounted boom viewing a soybean canopy. When viewing the crop, at a height of 4.2 meters, the diameter of the  $15^\circ$  field of view is 1.1 meters. Figure F-2 shows the boom rotated for the calibration operation. To ensure filling the field of view during the calibration operation, the instrument is positioned at a height of about 2 meters above the 1.2 meter square painted barium sulfate reference panel. At this distance, the diameter of the field of view, 0.53 meters, can be confidently located on the reference surface. For this mounting technique, the time from the nearest calibration is about 8 minutes. Reference surface data is interpolated to compute inband reflectance factors for each of the 15 plots which were measured (twice) during the interval.

Similar procedures are used with the other instruments described below.

#### 5. Reference Surfaces

As listed above, an assumption for measuring BRF is that the reflectance properties of the reference surface are known. Three kinds of reference surfaces have been used by Purdue/LARS and NASA/JSC for field research. They are pressed barium sulfate powder, painted barium sulfate, and canvas. The canvas reference surfaces are about 6 by 12 meters and are painted with a durable, diffuse paint. The nominal reflectance of the canvas panel is around 60 percent. All three reference surfaces are highly diffuse (for the solar angles encountered) and have medium to high reflective properties. Each of the reference surfaces were used to meet the requirements for a given instrumentation system. The spectral bidirectional reflectance factor for the three reference surfaces are illustrated in Figure F-3. Figure F-4 illustrates the goniometric properties

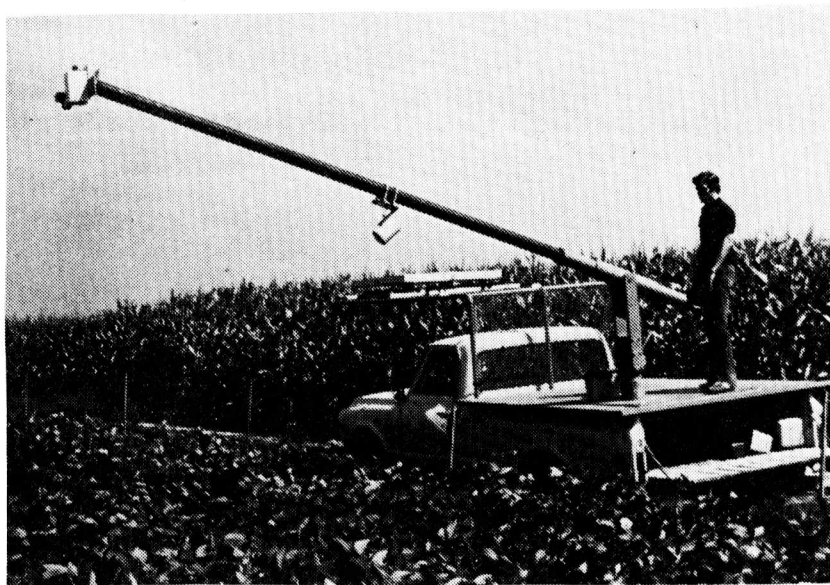

Figure F-1. Truck-mounted multiband radiometer viewing a soybean canopy.

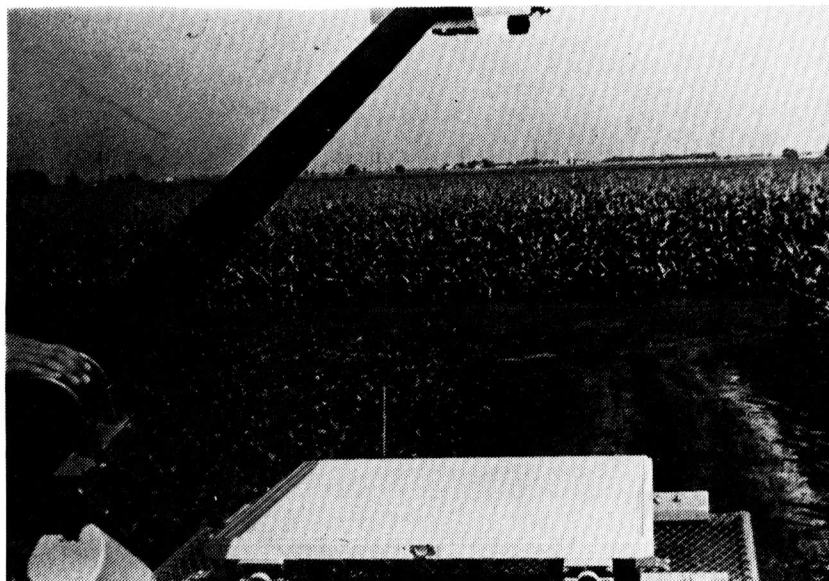

Figure F-2. Multiband radiometer positioned over painted barium sulfate reference panel for field reflectance calibration.

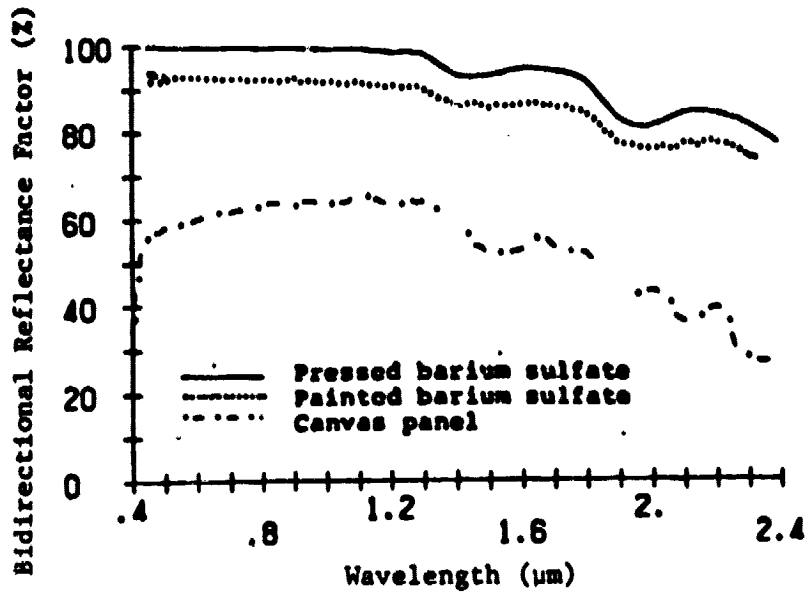

Figure F-3. Spectral bidirectional reflectance factor of three reference surfaces used for field research.

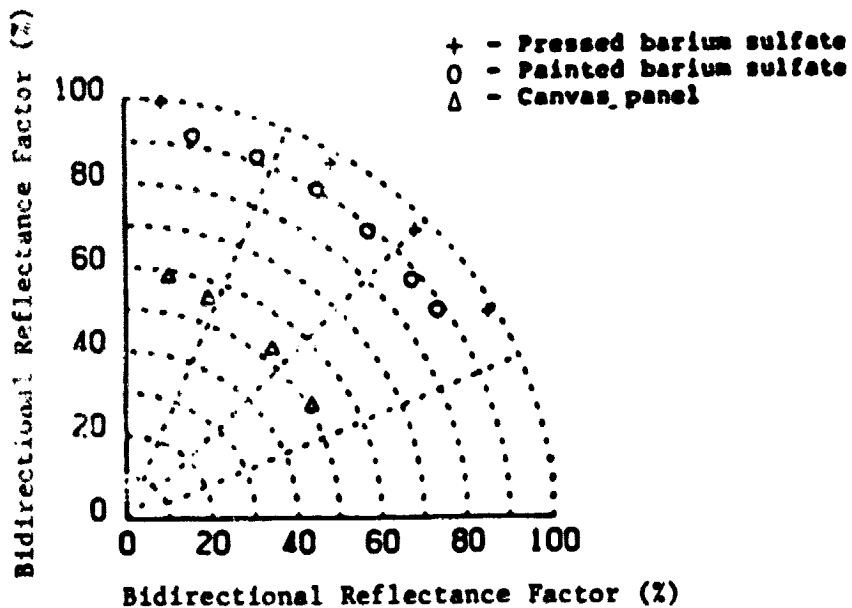

Figure F-4. Bidirectional reflectance factor at 0.6 μm, for several incident angles,  $\theta$ , and reference surfaces. Polar coordinates.

of the three reference surfaces from 5 to 55 degrees off normal at 0.6  $\mu\text{m}$ . The spectral goniometric properties of painted barium sulfate and canvas are shown in Figures F-5 and F-6 respectively. The BRDF calibration transfer for the reference surfaces is illustrated in Figure F-7.

Pressed barium sulfate is highly reflective (Figure F-3) from 0.4 to 2.4 $\mu\text{m}$ (5,6) and differs no more than 3% from Lambertian (Figure F-4) for 0 to 55 degree zenith angles. Pressed barium sulfate is primarily used as an indoor laboratory standard to calibrate the field painted barium sulfate reference surfaces. The pressed barium sulfate is used at incident angles of 10 degrees off normal in the indoor laboratory setup (7).

Painted barium sulfate is highly reflective (Figure 3) from 0.4 to 2.4 $\mu\text{m}$  when prepared as described by Shai and Schutt.(8) If applied properly, painted barium sulfate differs no more than 5% from Lambertian for 0 to 55 degree zenith angles (Figures F-4 and F-5). Painted barium sulfate panels are used as the reference surfaces for truck-mounted spectrometer/multiband radiometer systems. The solar zenith angles normally allowed or encountered during data collection by truck-mounted systems are 15 to 45 degrees.

The canvas panel is medium reflective (Figure F-3) from 0.4 to 2.4  $\mu\text{m}$ , and differs no more than 8% from Lambertian for 0 to 55 degree zenith angles (Figures F-4 and F-6). The canvas panel is used as the reference surface for a helicopter-mounted spectrometer system. The solar zenith angles normally allowed or encountered during data collection by the helicopter-mounted system are 15 to 55 degrees.

#### 6. Effects of Non-Directional Illumination

As indicated above, an assumption for the measurement of BRDF is that the incident radiation is directional. Clouds and skylight cause the irradiance of the subject and reference surface to be other than directional. Clouds can be avoided by taking data on clear days. Skylight, which can not be avoided, will be discussed first.

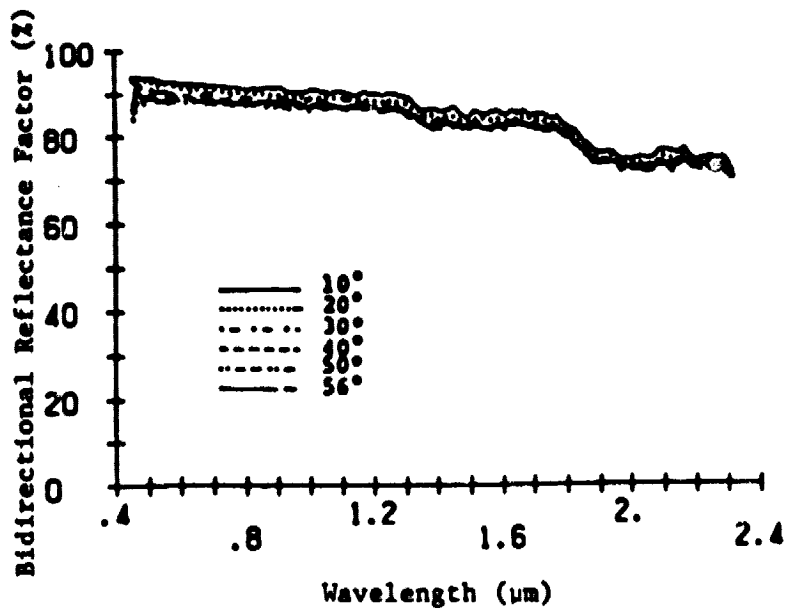

Figure F-5. Spectral bidirectional reflectance factor of painted barium sulfate for several incident angles (view angle is normal).

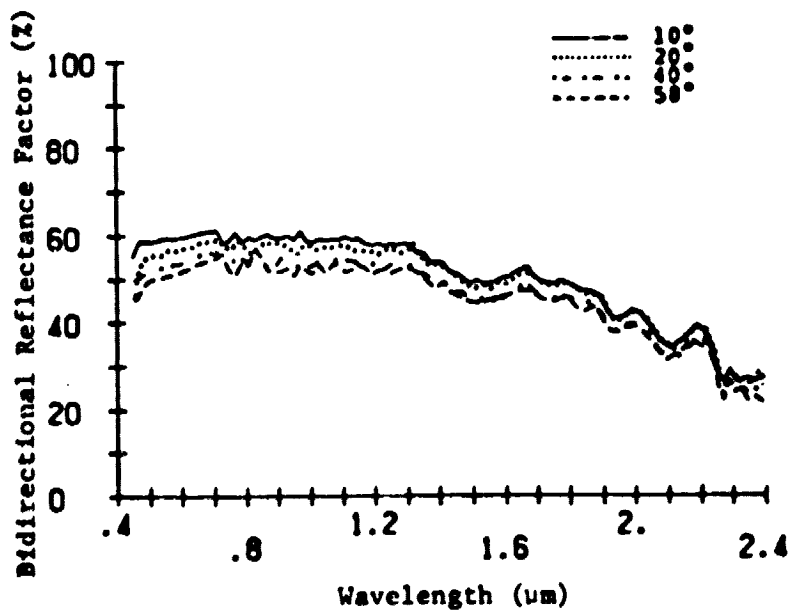

Figure F-6. Spectral bidirectional reflectance factor of a canvas panel for several incident angles (view angle is normal).

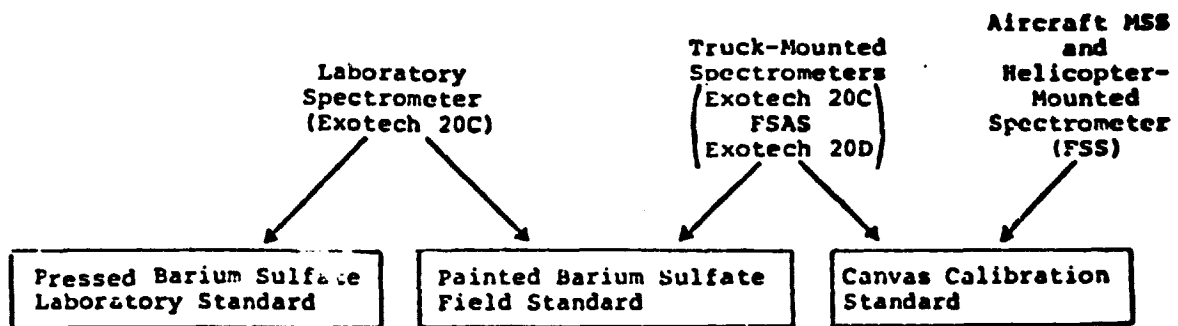

Figure F-7. Bidirectional reflectance factor calibration transfer of reference surfaces used for agricultural field research.



### 6.1 Effects of Skylight

Some of the flux incident upon the subject and reference is due to scattered sunlight. The effects of this component (skylight) may be treated by assuming that the radiance of the hemisphere is uniformly distributed. This is a conservative assumption in that the skylight is brightest in the vicinity of the solar disc (9). This increases the directional nature of the irradiance and the results need to be (and are) modified slightly to compensate for this assumption. The radiance of the surface is assumed to have a direct component,  $dL_D$ , due to radiation from the direction of the sun and a diffuse component,  $dL_d$ , due to uniformly distributed skylight.

$$dL(\theta_i, \phi_i; \theta_r, \phi_r) = f(\theta_i, \phi_i; \theta_r, \phi_r) dE_D(\theta_i, \phi_i) + \int_{2\pi} f(\theta_i, \phi_i; \theta_r, \phi_r) L_d(\theta_i, \phi_i) d\Omega_i \quad (2)$$

where incident and reflected angles are subscripted and i and r, respectively and

$dL(\theta_i, \phi_i; \theta_r, \phi_r)$  is the radiance in the direction  $(\theta_r, \phi_r)$  ( $W \cdot m^{-2} \cdot sr^{-1}$ )

$f(\theta_i, \phi_i; \theta_r, \phi_r)$  is the bidirectional reflectance distribution function of the surface ( $sr^{-1}$ )

$dE_D(\theta_i, \phi_i)$  is the directional component of the irradiance ( $W \cdot m^{-2}$ )

including sun and directional irradiance of sky covered by solar disc.

$L_d(\theta_i, \phi_i)$  is the diffuse radiance of the sky,  $\frac{E_d}{\pi}$  ( $W \cdot m^{-2} \cdot sr^{-1}$ )

$E_d$  is the total diffuse irradiance from the hemisphere ( $W \cdot m^{-2}$ )

and

$$d\Omega_i = \cos\theta_i \sin\theta_i d\theta_i d\phi_i \text{ (sr).}$$

For viewing along a normal to the surface

$$dL(\theta_i, \phi_i; 0, 0) = f(\theta_i, \phi_i; 0, 0) dE_D(\theta_i, \phi_i) + \frac{E_d}{\pi} \rho_t(2\pi; 0, 0)$$

where  $\rho_t$  is the hemispheric-normal reflectance of the subject and

$$\rho_t(2\pi; 0, 0) = \int_{2\pi} f(\theta_i, \phi_i; 0, 0) d\Omega_i.$$

Assuming that the radiance is uniform over the field of view and that the directional irradiance is uniform and collimated, the reflectance factor for a normally viewed surface, in the presence of skylight, is:

$$R_F(\theta_1, \phi_1; 0, 0) = \frac{f_t(\theta_1, \phi_1; 0, 0) dE_D(\theta_1, \phi_1) + \frac{\rho_t}{\pi} E_d}{f_s(\theta_1, \phi_1; 0, 0) [dE_D(\theta_1, \phi_1) + E_d]} \quad (3)$$

where t and s subscripts refer to "target" and "standard", respectively and the reference surface or standard is assumed to be Lambertian.

The structure of the subject and the reflectance characteristics of its components (i.e., leaves, tassels, soil background, etc.), combine to produce a complicated relationship between  $\rho_t$  and  $f_t(\theta_1, \phi_1; 0, 0)$ . However, for any sun angle pair  $(\theta_1, \phi_1)$ ,  $f_t$  may be greater or less than  $\frac{\rho_t}{\pi}$ . The relation may be expressed as

$$\frac{\rho_t}{\pi} = f_t(\theta_1, \phi_1; 0, 0) [1 + K_1(\theta_1, \phi_1)] \quad (\text{sr}^{-1}). \quad (4)$$

where  $K_1(\theta_1, \phi_1)$  simply represents the fractional amount by which  $f_t$  differs from  $\frac{\rho_t}{\pi}$ .

Then, Equation (3) becomes

$$R_F(\theta_1, \phi_1; 0, 0) = \frac{f_t(\theta_1, \phi_1; 0, 0)}{f_s(\theta_1, \phi_1; 0, 0)} \left[ 1 + \frac{K_1(\theta_1, \phi_1) E_d}{dE_D(\theta_1, \phi_1) + E_d} \right] \quad (5)$$

Defining the ratio of the diffuse irradiance to the total irradiance to be

$$K_2(\theta_1, \phi_1) = \frac{E_d}{dE_D(\theta_1, \phi_1) + E_d} :$$

$$R_F(\theta_1, \phi_1; 0, 0) = R_t(\theta_1, \phi_1; 0, 0) [1 + K_1 \cdot K_2] \quad (6)$$

where  $R_t(\theta_1, \phi_1; 0, 0)$  is the true bidirectional reflectance factor for normal viewing.

$K_1(\theta_1, \phi_1)$  varies with wavelength, structure of the canopy, etc. An estimate of  $K_1$  can be obtained from measurements of  $f_t(\theta_1, \phi_1; \theta_r, \phi_r)$  spaced across the hemisphere; however, solar zenith angles less than  $15^\circ$  do not occur at our latitudes ( $40^\circ$  N) and  $f_t(0, 0; 0, 0)$  has to be estimated.

For a variety of laboratory and field subjects viewed normally and illuminated at angles by a collimated source, it has been shown that 85% to 90% of the variance of the instrument response is explained by  $\cos\theta_1$  (10). Examination of functions  $f_t(\theta_1, \phi_1; 0, 0)$  which resemble typical experimental results indicates that those functions, which satisfy the 85% to 90% criterion mentioned above, yield  $|K_1| \leq 0.15$  for solar zenith angles used for normal data acquisition.

To serve as an example we select a function,  $\hat{f}_t$ , which resembles a bidirectional reflectance distribution for vegetation and has a normal-hemispheric reflectance,  $\rho_t$ . Ignoring azimuthal effects, we let

$$\hat{f}_t(\theta_1, \phi_1; 0, 0) = \frac{5}{4} \frac{\rho_t}{\pi} (\cos\theta_1)^{1/2} (\text{sr}^{-1}) \quad (7)$$

Then, since  $\rho_t(2\pi; 0, 0) = \int_{2\pi} \hat{f}_t(\theta_1, \phi_1; 0, 0) d\Omega_1$ ,

$$\rho_t = \rho_t(2\pi; 0, 0) = \int_0^{2\pi} \int_0^{\pi/2} \frac{5}{4} \frac{\rho_t}{\pi} (\cos\theta_1)^{1/2} \sin\theta_1 \cos\theta_1 d\theta_1 d\phi_1 \quad (8)$$

A comparison of  $\hat{f}$  and the constant  $\rho_t/\pi$ , the reflectance distribution function of a Lambertian surface, is shown in Figure F-8. The relative responses of an instrument viewing normally scenes, characterized by  $\hat{f}_t$  and  $\rho_t/\pi$ , that are illuminated with a collimated constant intensity source at several angles,  $\theta$ , are shown in Figure F-9. The angular response for

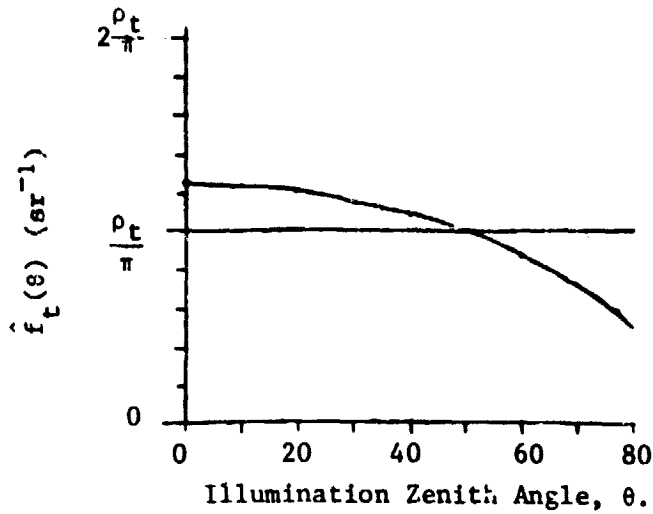

Figure F-8. Comparison of the functions  $\hat{f}_t$  and  $\frac{\rho_t}{\pi}$  as a function of illumination angle,  $\theta$ .

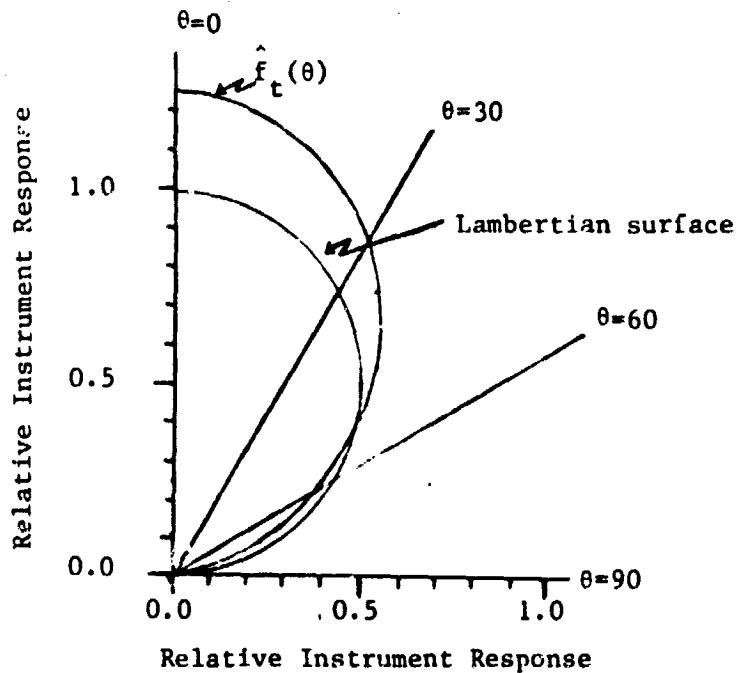

Figure F-9. Polar plot of comparison of relative response of a normal viewing instrument to a scene characterized by  $\hat{f}_t$  and a Lambertian scene as a function of illumination angle,  $\theta$ .

the subject satisfies the 85% to 90% criterion in that 88% of the variance of the response is explained by  $(\rho_t/\pi)\cos\theta_1$ .

From Equation 4, values of  $K_1(\theta_1)$  are computed and shown in Figure F-10. Figure F-10 indicates that with the assumption of uniformly distributed skylight,  $|K_1| \leq 0.2$  for all angles from 0 to 63 degrees. To take into account the directional nature of the skylight, we consider that much of skylight originates from the vicinity of the solar disk and that flux is reflected by the average value of  $\hat{f}_t(\theta_1)$  over the range of  $\theta_1$  (11). Thus, much of the skylight is reflected by effectively the same reflectance distribution function as the direct component is reflected. Therefore, a value of  $|K_1| \leq 0.1$  is felt to be justified.

The ratio of the diffuse irradiance to the total irradiance is:

$$K_2 = K_2(\theta, \phi) \quad (9)$$

This ratio varies with wavelength, sun angle, and atmospheric conditions.  $K_2$  has been modeled and measured for a variety of conditions and typical values are presented in Table F-1.

From Table F-1, the maximum value of  $K_1 \cdot K_2$  is 0.03. Therefore, the reflectance factor measured including the skylight will differ from the true reflectance factor by a systematic 3% of value on a hazy day (visibility = 8 km) for the spectral band 0.5 to 0.6 $\mu$ m (9,12).

## 6.2 Effects of Clouds

As a large cumulus cloud approaches the solar disc, a sensor of global irradiance will indicate increased intensity (as much as 30% is typical). Then, as the cloud begins to cover the solar disc, the intensity decreases markedly (typically to 20% of the original intensity). Thus, any measurement made during these events will be subject to error due to intensity changes with time. More importantly, a sizeable error can be introduced by the marked difference in direction of the light from the cloud. Unlike the skylight, the cloud has no compensating effect on the other side of the sun. Therefore, under these conditions, even a complete measurement made in an instant will be subject to sizeable error.

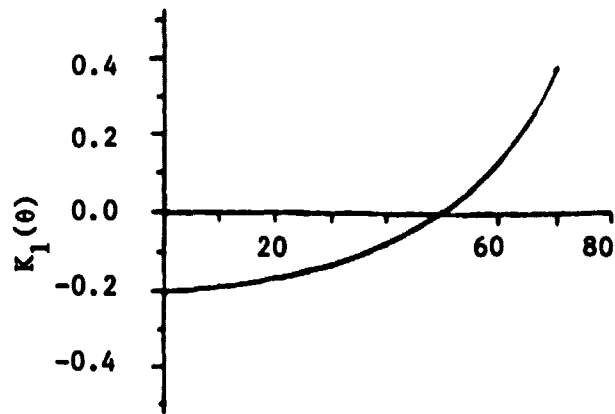

Illumination Zenith Angle,  $\theta$ .

Figure F-10. Plot of the fractional difference between  $f_t$  and  $\frac{\rho_t}{\rho}$ ,  $K_1$ , as a function of illumination angle,  $\theta$ .

Table F-1. Determination of the variation ( $K_1 K_2$ ) of the measured bidirectional reflectance factor from the true bidirectional reflectance factor.

Spectral Range ( $\mu\text{m}$ )	Ratio of diffuse to total irradiance ( $K_2$ )		$K_1 \cdot K_2$ for $K_1 = 0.1$	
	Visibility		Visibility	
	8 Km	23 Km	8 Km	23 Km
0.5 - 0.6	.30	.07	.03	.007
0.6 - 0.7	.23	.05	.02	.005
0.7 - 0.8	.20	.03	.02	.003
0.8 - 1.0	.15	.02	.02	.002
1.55- 1.75	.05	.02	.01	.002
2.1 - 2.3	.05	.05	.01	.005

Frequently, clouds will appear on the horizon on an otherwise clear day; their effect is diminished in that they irradiate from a large  $\theta_1$ . For example, using  $\hat{f}(\theta)$  defined above, the radiance of the subject due to clouds on the horizon is:

$$L_{cc} = \int_a^b \int_a^{\pi/2} L_c \hat{f}(\theta_1) \cos\theta_1 \sin\theta_1 d\theta_1 d\phi_1 \quad (\text{W}\cdot\text{m}^{-2}\cdot\text{sr}^{-1}) \quad (10)$$

where  $L_c$  is the constant radiance of the clouds,  $a$  and  $b$  are angles describing the azimuthal range of the clouds and  $\alpha$  is the zenith of the top of the range of clouds.

$$L_{cc} = k \rho_c E_D \rho_t (\cos\alpha)^{5/2} \quad (\text{W}\cdot\text{m}^{-2}\cdot\text{sr}^{-1}) \quad (11)$$

where  $k$  is the fraction of the azimuthal horizon encompassed by the clouds and  $\rho_c$  is the reflectance of the clouds ( $\rho_c > 50\%$ ) over the reflective spectral range. From this it may be determined that bands of clouds covering half the horizon to an elevation of 20 degrees (zenith of 70 degrees) will produce little effect on the measurement of reflectance factor. Furthermore, a few stationary low and middle clouds at large angles from the solar disc can be shown to produce little effect as long as they do not subtend a significant solid angle of the hemisphere.

The effects of thin cirrus clouds are the most frustrating. If they are widely distributed, they contribute errors related to  $K_1(\theta_1, \phi_1)$ , discussed above, by increasing the "skylight". As well, they cause changes in the intensity of the direct component of the irradiance by moving (sometimes rapidly) across the solar disc. However, there are days when, for sufficiently long periods, the variation of intensity due to thin cirrus is less than  $\pm 1\%$ . Sometimes, on such days, we continuously monitor the total and spectral irradiance and succumb to the temptation to take data and correct for the changes, ignoring the effects on  $K_1$ .

For completely overcast days, the intensity of the irradiance changes rapidly and unpredictably with occasional periods of relative constancy. During the "constant" periods, a poor approximation to  $f(2\pi; 0, 0)$  can be measured.

However, since we are interested in the directional properties (to relate to satellite sensed data), these days are best spent on other activities.

#### 7. Comparison of Spectral Bidirectional Reflectance Factor Measurements made by Three Spectrometer Systems

During the Large Area Crop Inventory Experiment (LACIE) (3), four different spectroradiometer systems were used to collect agricultural field spectral BRF measurements. The spectroradiometer systems were used in five different test sites in North Dakota, South Dakota, and Kansas. Common scenes, canvas panels, were transported between the test sites to be used for the reflectance calibration of a helicopter mounted spectrometer and if researchers desire, aircraft scanner data. In July of 1977, three of the spectrometer systems were brought together to the Williams county, North Dakota, test site for a formal comparison study. The three spectrometer systems were:

- Exotech 20C Field Spectrometer System, a circular variable filter-wheel, truck-mounted instrument operated by Purdue/LARS
- Field Spectrometer System (FSS), a circular variable filterwheel, helicopter-mounted instrument operated by NASA/JSC
- Field Signature Acquisitions System (FSAS), an interferometer, truck-mounted instrument operated by NASA/JSC.

The fourth spectrometer system, the NASA/ERL Exotech 20D, was used during 1975 only. All four instrument systems measured the spectral bidirectional reflectance factor of agricultural crops, primarily small grains, from 0.4 to 2.4 $\mu$ m. The field techniques and reference surfaces normally used by the crews of each of the instrument systems were used during the measurements of the common scenes for the comparison study. The scenes were six gray canvas panels, and a green canvas panel. The gray panels represent scenes with relatively constant spectral characteristics at different reflectance levels; the green panel represents a scene with varying spectral character. The truck-mounted systems measured the spectral BRF of the seven panels on July 15 and 17, 1977, Figure F-11. The helicopter-mounted spectrometer system, the FSS, viewed the four gray panels on July 17, 1977: a fifth panel, the brightest, was the reference panel.



The FSS viewed the green panel on August 4, 1977. All measurements were collected with less than 15 minutes between measurements of the scene and the reference surface. The reference surface for the Purdue/LARS system was a 1.2 meter square painted barium sulfate panel viewed at 2.4 meters below the instrument. The reference surface for the NASA/JSC FSAS system was a 0.6 meter diameter circular painted barium sulfate panel viewed at 1.2 meters below the instrument. The reference surface for the NASA/JSC FSS system was a 6 x 12 meter canvas panel mounted on a solid, fixed platform at 6 meters below the instrument (Figure F-12).

The spectral BRF measurements by the three field systems of the canvas panels (5 to 60 percent), compared quite favorably, as illustrated in Figure F-13. The major difference in the three field systems occurs in the 0.9 to 1.8 $\mu$ m range for the green panel BRF measurements above 65 percent. The specific reason(s) for the differences have not been determined. A quantitative comparison of the measurements for three wavelengths is given in Figure F-14. If the measurements from the field systems were identical, the points in Figure F-14 would fall on the dashed line. A linear regression analysis was performed on each of the pair-wise system comparisons for each of the three wavelengths. The coefficients of determination,  $r^2$ , from the regression analysis were 0.994 or higher. The BRF measurements from the separate field systems agree to within 4 percent of value for BRF ranges from 5 to 60 percent, the normal range for most normally viewed agricultural crop canopies.

The results of the instrument comparison study indicate that the procedure developed for the measurement of BRF is sound. Moreover, quantitative information about the comparison of the measurements from different spectroradiometer systems is available. The use of common scenes such as canvas panels is a valuable aid in accessing the comparability of several spectrometer systems. The comparison can be done by bringing the systems together as was done for the above study or by transferring the common scenes from site to site.

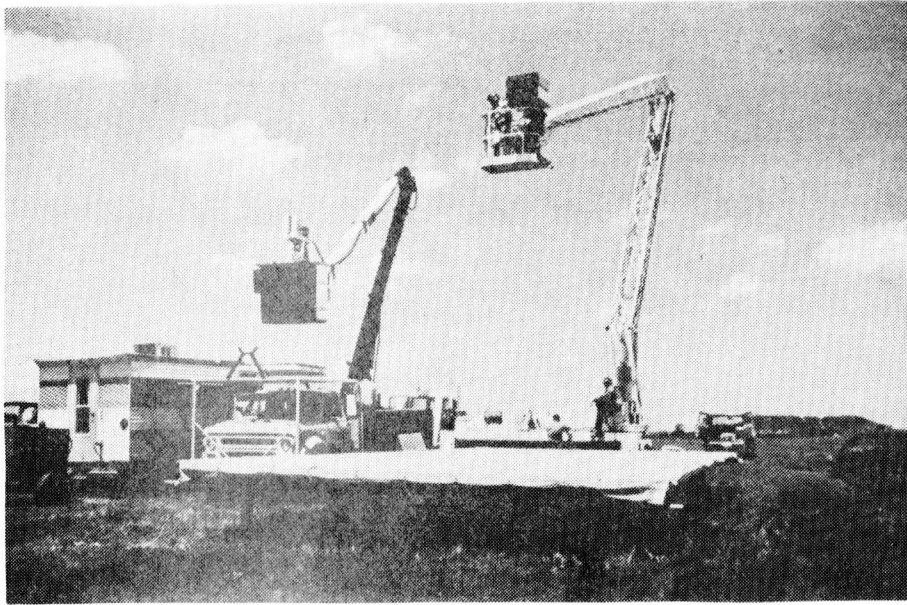

Figure F-11. Purdue/LARS Exotech 20C (left) and NASA/JSC FSAS (right) spectrometer systems viewing canvas panel.



Figure F-12. NASA/JSC field spectrometer system (FSS) viewing canvas reference panel.

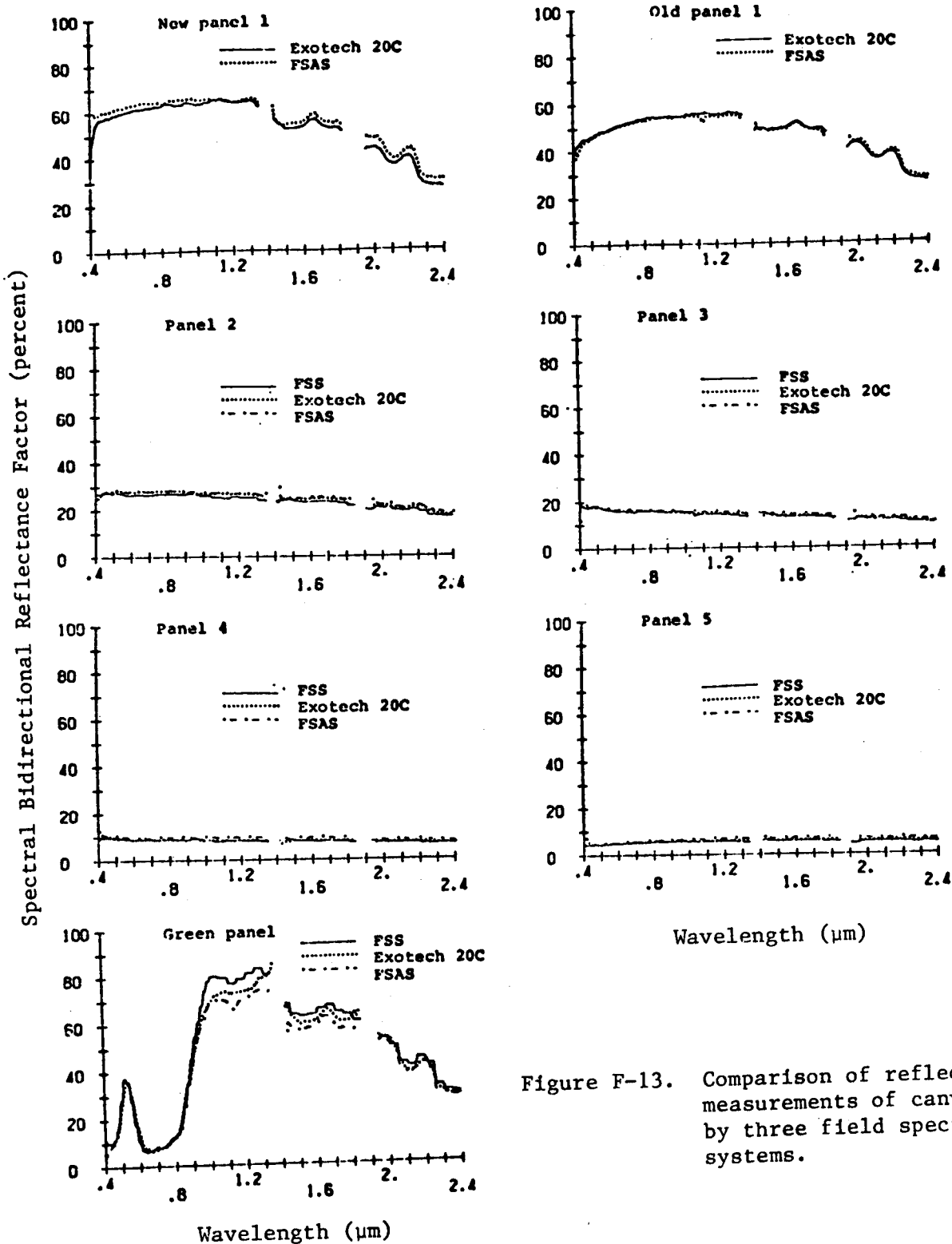

Figure F-13. Comparison of reflectance measurements of canvas panels by three field spectrometer systems.

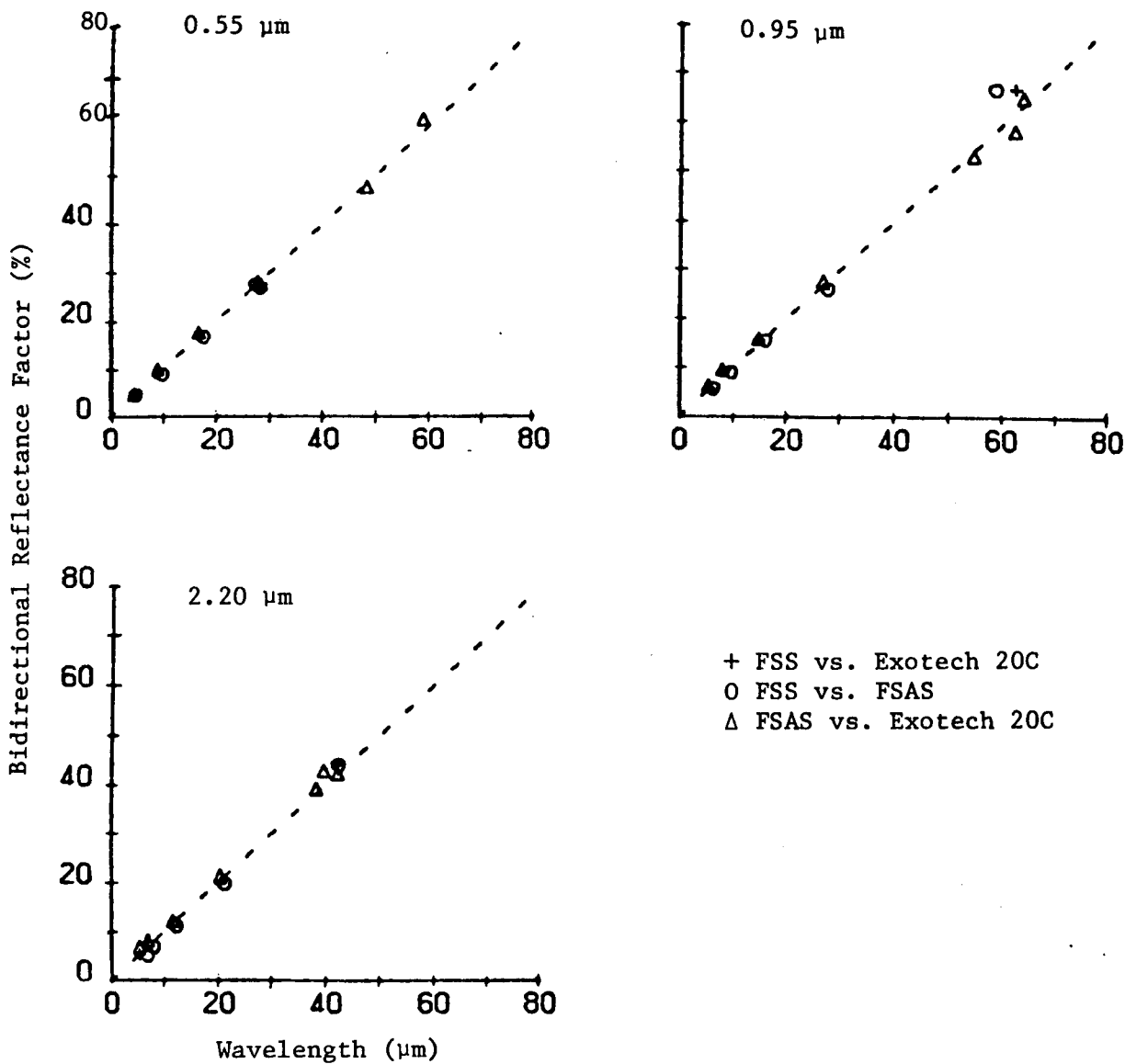

Figure F-14. Pairwise comparison of reflectance measurements of canvas panels by three field spectrometer systems at three wavelengths.

## 8. Conclusions

Bidirectional reflectance factor (BRF) is an appropriate and useful optical property for remote sensing field research because it is a fundamental property of the subject. The described procedures for use of reflectance surfaces provide a good approximation to the true BRF of the subject because the irradiance is dominated by its directional component, the reference surface is nearly Lambertian and the BRF of the subject is not radically different from Lambertian.

The described procedure is an effective means to acquire data which may be meaningfully compared from time to time, site to site, and instrument to instrument because:

- It is relatively easy to train instrument operators to obtain repeatable results
- The reference surfaces can be prepared and tested at central locations; therefore, most researchers do not need sophisticated calibration apparatus.
- The performance of different instruments can be easily compared under field conditions.

Acquisition of meaningful data requires that measurements be made at the appropriate scale. This entails positioning the sensor at a proper distance above the subject, and careful consideration of the field of view. Without careful planning, these factors and other procedural errors can seriously limit the usefulness of well calibrated data.

## 9. References

1. MacDonald, R. B. and F. G. Hall, "LACIE: An Experiment in Global-Crop Forecasting." Proceedings of the LACIE Symposium, NASA/Johnson Space Center, Houston, Texas, October 1978, Document No. JSC-14551, pp. 17-48.
2. Landgrebe, D. A., "Monitoring the Earths Resources from Space - Can You Really Identify Crops by Satellite?", American Federation of Information Processing Systems (AFIPS) Conference Proceedings. Vol 48, pp. 233-241, AFIPS Press, Montvale, NJ, 07645, 1979.

3. Bauer, M.E., M.C. McEwen, W.A. Malila, and J.C. Harlan, "Design Implementation and Results of LACIE Field Research," Proceedings of the LACIE Symposium, NASA/Johnson Space Center, Houston, Texas, October 1978, Document No. JSC-16015, pp. 1037-1066.
4. Nicodemus, F.E., et al., Geometrical Considerations and Nomenclature for Reflectance, NBS Monograph 160, U.S. Govt. Printing Office, Washington, D.C. 20402, October 1977.
5. Gram, F. and G. W. Luckey, "Optical Sphere Paint and a Working Standard of Reflectance." Applied Optics, Vol. 7, No. 11, pp. 2289-2294, November 1978.
6. Billmeyer, F. W. Jr., D. L. Lewis and James G. Davidson, "Goniometry of Pressed Barium Sulfate," Color Engineering, May-June 1971.
7. DeWitt, D. F. and B. F. Robinson, Description and Evaluation of a Bidirectional Reflectance Factor Reflectometer, Technical Report 091576, Purdue University, Laboratory for Applications of Remote Sensing, September 1976.
8. Shai, C. M. and J. B. Schutt, "Formulation Procedure and Spectral Data for a Highly Reflecting Coating From 200 nm to 2300 nm," Doc. X-762-71-266, NASA/Goddard Space Center, Greenbelt, MD, July 1971.
9. Turner, R. E., W. A. Malila, and R. F. Nalepka, "Importance of Atmospheric Scattering in Remote Sensing," Proceedings of the Seventh International Symposium on Remote Sensing of the Environment, The University of Michigan, pp. 1651-1696, 1971.
10. Egbert, D. D., "A Practical Method for Correcting Bidirectional Reflectance Variations," Proceedings of the Fourth Symposium on Machine Processing of Remotely Sensed Data, Purdue University, Laboratory for Applications of Remote Sensing, pp. 178-192, 1977.
11. Wolfe, W. L. and G. J. Zissos (eds.), The Infrared Handbook, Office of Naval Research, Department of the Navy, Washington, D. C., pp. 343, 1978.
12. Duggin, M. J., "On the Natural Limitations of Target Differentiation by Means of Spectral Discrimination Techniques," Proceedings of the Ninth International Symposium on Remote Sensing of the Environment, Environmental Research Institute of Michigan, Ann Arbor, Michigan, pp. 499-515, 1974.

DISTRIBUTION LIST

Contract NAS9-15466

NAME

NUMBER OF COPIES

NASA/Johnson Space Center  
Houston, Texas 77058

ATTN: Mr. W.E. Rice/SA	(1)
Mr. R.B. MacDonald/SA	(1)
Mr. R.B. Erb/SF	(1)
Dr. F.G. Hall	(1)
Dr. J.D. Erickson/SF3	(1)
Mr. J.L. Dragg/SF4	(1)
Dr. O.G. Smith/SF5	(1)
Mr. D.H. Hay/SF6	(1)
Mr. R.L. Eason/SF2	(2)
Mr. W.E. Hensley/SF2	(1)
Mr. K. Baker/SF3	(1)
Dr. D.E. Pitts/SF3	(1)
Mr. M.C. Trichel/SF3	(1)
Dr. D.R. Thompson/SF3	(1)
Dr. R.P. Heydorn/SF3	(1)
Dr. K.E. Henderson/SF3	(1)
Mr. V.S. Whitehead/SF3	(1)
Mr. I.D. Browne/SF3	(5)
Mr. K.J. Demel/SF3	(1)
Mr. R.M. Bizzell/SF4	(1)
Dr. C.R. Hallum/SF4	(1)
Mr. R.O. Hill/SF4	(1)
Dr. G.E. Graybeal/SF5	(1)
Dr. F.P. Weber/SF5	(1)
Mr. D.L. Amsbury/SF5	(1)
Mr. J.C. Lyon/SF6	(1)
Mr. K. Bulow/SF6	(1)
Mr. B.L. Carroll/CO9	(1)
Ms. R. Shirkey/JM6	(4)
Public Affairs Office/AP	(1)

NASA Headquarters  
Washington, D.C. 20546

ATTN: Mr. Pitt G. Thome/ER-2	(1)
Ms. Ruth I. Whitman/ERL-2	(1)

National Aeronautics and Space Administration Scientific and Technical Information Facility Code KS Washington, D.C. 20546	(1)
---	-----

NAMENUMBER OF COPIES

NASA/Goddard Space Flight Center  
Greenbelt, Maryland 20771

ATTN: Mr. W. Alford/563 (1)  
Dr. J. Barker/923 (1)  
Dr. L. Walter/920 (1)  
Dr. W.G. Stroud/900 (1)  
Dr. V.V. Salmonson/913 (1)

Mr. D.W. Mooneyhan (1)  
NASA/Earth Resources Laboratory/GS  
Mississippi Test Facility  
Bay St. Louis, Mississippi 39520

Dr. Herman Mark (1)  
NASA/Lewis Research Center  
21000 Brookpark Road  
Cleveland, Ohio 44135

Mr. Fred Billingsley (1)  
Code 168-427  
Jet Propulsion Laboratory  
4800 Oak Grove Drive  
Pasadena, California 91103

Mr. J.P. Claybourne/AA-STA (1)  
NASA/Kennedy Space Center  
Kennedy Space Center, Florida 32899

Dr. Harold Maurer (1)  
NASA Wallops  
Wallops Station, Virginia 23337

U.S. Department of Agriculture  
Economics, Statistics and Cooperatives Services  
Washington, D.C. 20250

ATTN: Mr. W.H. Wigton (1)  
Mr. R.D. Allen (1)  
Dr. G.F. Hart (1)  
Dr. W.E. Kibler (1)

Dr. G. Boatwright (1)  
USDA/AgRISTARS  
1050 Bay Area Blvd.  
Houston, Texas 77058

Dr. Craig Wiegand (1)  
U.S. Department of Agriculture  
Soil & Water Conservation Research Div.  
P.O. Box 267  
Weslaco, Texas 78596



NAMENUMBER OF COPIES

Dr. Ray Jackson (1)  
U.S. Department of Agriculture  
Water Conservation Laboratory  
4331 East Broadway  
Phoenix, Arizona 85040

Dr. Richard Driscoll (1)  
U.S. Department of Agriculture  
Forest Service  
240 W. Prospect Street  
Fort Collins, Colorado 80521

U.S. Department of Agriculture  
SEA/AR  
Bldg. 005, BARC-West  
Beltsville, Maryland 20705

ATTN: Mr. Carl W. Carlson (1)  
Dr. Jerry Ritchie (1)

Mr. Jimmy D. Murphy (1)  
U.S. Department of Agriculture  
FAS/CCAD  
1050 Bay Area Blvd.  
Houston, Texas 77058

Mr. W.A. Fischer (1)  
U.S. Department of Interior  
Geological Survey  
GSA Building, Room 5213  
Washington, D.C. 20242

U.S. Department of Interior  
EROS Office  
Washington, D.C. 20242

ATTN: Dr. Raymond W. Fary (1)  
Mr. William Hemphill (1)

U.S. Department of Interior  
USGS National Center  
Mail Stop 710  
Geography Program  
Reston, Virginia 22092

ATTN: Dr. James R. Anderson (1)  
Mr. James Wray (1)

Mr. Fred Doyle (1)  
U.S. Department of Interior  
Geological Survey  
1925 Newton Square East  
Reston, Virginia 22092

NAMENUMBER OF COPIES

Mr. Allen Watkins U.S. Department of Interior EROS Data Center Sioux Falls, South Dakota 57198	(1)
Dr. Norton Strommen NOAA/Climatic Impact Assessment Division 3300 Whitehaven, NW Page Bldg. 2, Rm 139 Washington, D.C. 20235	(1)
Dr. Wendell Wilson NOAA/CEAS Federal Bldg. Columbia, Missouri 65201	(1)
Environmental Research Institute of Michigan P.O. Box 8618 Ann Arbor, Michigan 48107	
ATTN: Mr. R. Horvath	(1)
Dr. W.A. Malila	(1)
Mr. R.C. Cicone	(1)
Mr. R.J. Kauth	(1)
Dr. Q.A. Holmes	(1)
Dr. AM.M Feyerherm Kansas State University Department of Statistics, Calvin 19 Manhattan, Kansas 66506	(1)
Dr. E.T. Kanemasu Department of Agronomy Kansas State University Manhattan, Kansas 66506	(1)
Mr. Stanley Wheeler IBM Corporation FSD Mail Code 56 1322 Space Park Drive Houston, Texas 77058	(1)
Dr. L.F. Guseman, Jr. Department of Mathematics Texas A&M University College Station, Texas 77843	(1)
Dr. H.O. Hartley Duke University Dept. of Statistics Durham, North Carolina 27705	(1)
Ms. Claire M. Hay 260 Space Sciences Lab University of California-Berkeley Berkeley, California 94720	(1)

NAMENUMBER OF COPIES

Dr. W.A. Coberley Mathematics-Sciences Depart. University of Tulsa 600 South College Tulsa, Oklahoma 74104	(1)
Dr. C.J. Johannsen Agronomy Department University of Missouri-Columbia Columbia, Missouri 65211	(1)
Dr. James A. Smith Department of Forest and Wood Sciences Colorado State University Fort Collins, Colorado 80521	(1)
Dr. John E. Estes Dept. of Geography University of California-Santa Barbara Santa Barbara, California 93106	(1)
Dr. David Simonett Dept. of Geography University of California-Santa Barbara Santa Barbara, California 93106	(1)
Dr. Robert Colwell School of Forestry Univeristy of California-Berkeley Berkeley, California 94720	(1)
Dr. Barry J. Schrupf Environmental Remote Sensing Applications Laboratory Oregon State University Corvallis, Oregon 97331	(1)
Dr. Stanley Morain Remote Sensing Research Technology Application Center University of New Mexico Albuquerque, NM 87131	(1)
Dr. Ron J.P. Lyon School of Earth Sciences Remote Sensing Laboratory Stanford University Stanford, CA 94305	(1)
Dr. Fawwaz Ulaby Remote Sensing Laboratory University of Kansas Lawrence, Kansas 66045	(1)

NAMENUMBER OF COPIES

Mr. Victor I. Myers Remote Sensing Institute South Dakota State University Agriculture Engineering Building Brookings, South Dakota 57006	(1)
Dr. J.C. Harlan Texas A&M University Remote Sensing Center Collete Station, Texas 77843	(1)
Dr. A.B. Park General Electric Co. Space Systems Dept. 5030 Herzel Place Beltsville, Maryland 20705	(1)
Dr. David Goodenough Canada Centre for Remote Sensing 2464 Sheffield Road Ottawa, Canada K1A 0Y7	(1)