

Reprinted from

Seventh International Symposium

Machine Processing of

Remotely Sensed Data

with special emphasis on

Range, Forest and Wetlands Assessment

June 23 - 26, 1981

Proceedings

Purdue University
The Laboratory for Applications of Remote Sensing
West Lafayette, Indiana 47907 USA

Copyright © 1981

by Purdue Research Foundation, West Lafayette, Indiana 47907. All Rights Reserved.

This paper is provided for personal educational use only,
under permission from Purdue Research Foundation.

Purdue Research Foundation

FORESTRY AS A TECHNOLOGY DRIVER

ARCH PARK

General Electric
Lanham, Maryland

ABSTRACT

Remote sensing in forestry has always provided a severe challenge to the sensor/platform hardware. It combines high resolution requirements, in real time, from a variety of platforms with a requirement for spectral precision and cartographic accuracy. Few if any other applications can, by themselves, create such a worst case scenario. The paper looks at the past, present and future technology demands of forestry.

Throughout the history of the research in satellite remote sensing, forestry has provided the hardware designer with requirements which are technically difficult to meet. This has led to innovation on the part of the research community which may have had its beginnings as a "solution" to a hardware deficiency but has since been perceived as a useful procedure in its own right. Langley's work in multistage sampling (Fig. 1) is an outstanding example of such innovation. The exploitation of multistage imagery in lieu of the "ideal" data by many investigators is another.

Multistage Sampling - Forestry

(Figure 1)

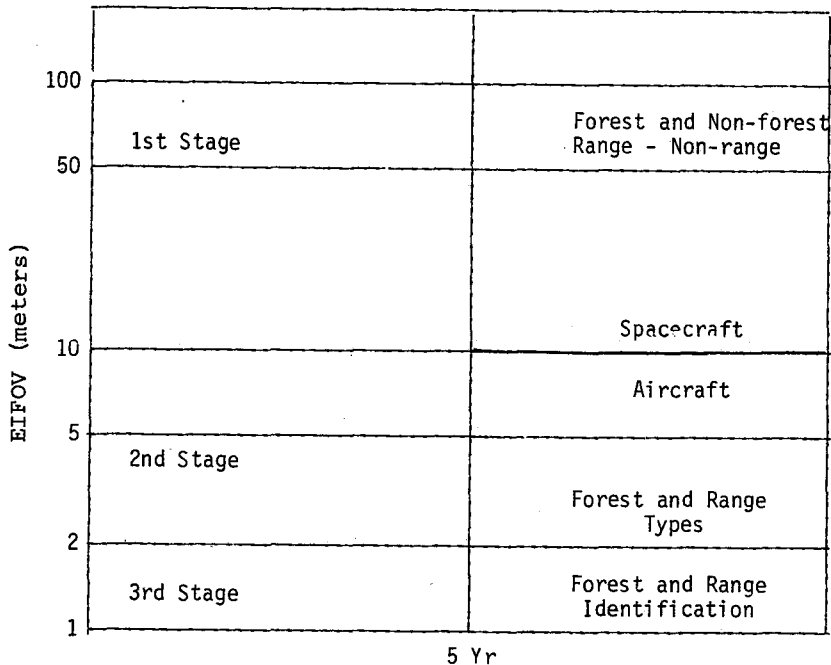

Although there were early attempts to document requirements by individuals representing various elements of the government, virtually all of them were modified after Landsat was launched and subsequently studied by the research community. It is noteworthy that perhaps the least affected or changed by Landsat was the forestry requirement. One could conclude properly that this resulted because of the experience of the government/university team performing the research. There were, however, some significant changes in procedure created by the research hardware in use during the period 1965 - 1972. Most notable was a realization that it was not necessary to

fly "low and slow" to get adequate resolution. With the newer films, lenses and camera systems, the old convention of ordering photography by specifying scale yielded to the more accurate specification - resolution. Scale is now used as it should be; to specify the output product format.

One of the more interesting documents reviewed in preparing this paper was NASA SP335, Advanced Scanners and Imaging Systems for Earth Observations which, although published in 1972, covers the current technology era. In response to the hardware studies a group of users from the government was convened to examine requirements in the context of the projected hardware capability. (Fig. 2). Note that during that period satellite resolution was confined to the Landsat capability and anything better than that was categorized as an aircraft application.

Forestry Requirements
(Figure 2)

	Specific Applications and Parameters to be Measured	Desired Time of Acquisition	EIFOV (Meters)	Sequential Coverage (Yes or No) (I) indicates Probable Coverage Required	Estimated Working scale	Frequency for Determination of Application	Probable Platform	
Multistage Sampling Photography or Imagery	Forest Inventory							
	1. 1st level, Forest-Nonforest	Winter, Early Spring Spring & Winter Summer	50-100	Yes(2)	1:250,000	5 Yrs.	S/C	
	2. 2nd level, Forest Typing		2-5	Yes(2)	1:50,000	5 Yrs.	A/C	
	3. 3rd level, Tree Counts Crown diam., Indiv. Species Identification		< 1	No(1)	1:2,000 to 1:4,000	5 Yrs.	A/C	
	4. 4th level, Ground							
	Range Inventory							
	1. 1st level, Range-Nonrange		50-100	Yes	1:250,000	5 Yrs.	S/C	
	2. 2nd level, Range-Types		2-5	Yes (twice a year)	1:50,000	5 Yrs.	A/C	
3. 3rd level, Range Ident. & Trend		< 1	No (once a Year)	1:600	5 Yrs.	A/C		
4. 4th level, ground								
Continental Data Needs	1. Timberline	Early Sum.	50-100	No(1)	1:500,000	5 Yrs.	S/C	
	2. Waterline	Various	50-100	Yes(2)	1:500,000	Annual	S/C	
	3. Snowline	Winter	50-100	Yes(6)	1:500,000	Biweekly	S/C	
	4. Desertline	Various	50-100	No(1)	1:500,000	5 Yrs.	S/C	
	5. Grassland, Brushland Interface	Spring & Fall	50-100	Yes(2)	1:500,000	5 Yrs.	S/C	
	6. Bushland-Timberland Interface	Spring	50-100	Yes(3)	1:500,000	5 Yrs.	S/C	
	7. Grassland-Timberland Interface	Spring & Fall	50-100	Yes(2)	1:500,000	5 Yrs.	S/C	
	8. Bare Soil vs. Vegetated Areas	Spring & Sum.	30-50	Yes(3)	1:100,000	Annual	S/C	
	9. Major Roads, Railroads & Waterways	Sum. & Winter	30-50	Yes(2)	1:100,000	Annual	S/C	
	10. Plant Stress	Growing Season	2-5/30-50	Yes(4)	1:10,000	Weekly	A/C	
	11. Forest Engineering	Detection	Winter & Sum.	5-10	Yes(2)	1:100,000	Annual	A/C
	12. Areal Extent of Water Surfaces	Summer	5-10	Yes(2)	1:50,000	Annual	A/C	
	13. Urbanized Areas	Various	50-100	No(1)	1:250,000	Annual	S/C	
	14. Land Use Change	Various	30-50	Yes(6)	1:250,000	Annual	S/C	

In a more recent review of requirements, NOAA requested the user agencies of the state and federal government to document these requirements in the context of the pending operational Landsat system. It should be stated parenthetically that forestry had always provided "operational" requirements. There were, however, several important aspects to the NOAA initiative. First, during the interval between the NASA meeting in 1972 and the NOAA study of 1980, NASA had hosted an interagency team which worked during 1978 and '79 to collect, collate and analyze requirements for all levels of the government. This effort called the Integrated Remote Sensing Systems Study (IRS³) had several limitations:

- (i) they were not required to estimate data volumes
- (ii) there was no specific aircraft "set" of requirements
- (iii) requirements of the user market omitted (a) foreign users (b) commercial users
- (iv) quality of the input varied from agency to agency.

Concerning data quality it must be stated that the USDA input was extraordinary. Independently that department had created an internal working group to define their requirements. That body had worked for three years on the collection and analysis of the departments needs. They had only recently completed this work prior to the IRS³ effort. Thus they were able to provide a very comprehensive list for each agency of the department. To illustrate the level of detail, excerpts from the list are provided as Figure 3 from the Forest Service. Only two major categories are broken down into elements. This level of detail, however, was provided for all categories.

Figure 3

1. Primary Productivity Ecological Type Mapping	2. Forest Land Cover Types
Kinds of Vegetation Natural Open Areas Veg. by Species in Estuaries Unique Plant Communities Detect Monitor Plant Disease Biomass Annual Production Standing Crop of Biomass Accumulated Growth by Area Veg. in Vigor Class by Species Group Phenological Stag. by Species Group Locate Streamside Vegetation Biomass Usable Growth Plant Density by Species Accumulated Growth Horiz. Dist. Accum Growth by Specie Groups Veg. Distribution by Species Plant Density for Area Annual Growth for Area Flora by Species Number Size Vegetated Area Veg. Dist. by Species Groups Veg. in Vigor Class by Species Phenological Stage by Species Plant Density by Group Species Annual Growth Groups of Specie	Comm. Timber by Stand Age Class Map Streamside Trees Tree Stand Composition Natural Timber Composition Forest Type Distribution Map Timber Stand Boundaries Forest Land by SAF Cover Type Natural Timber Stand Location Forest Types Natural Timber Stands Natural Timber Locate & Excent Map Trees Forestland Land Use Vegetation Types by Species Identify Vegetation by Types Vegetation Types by Species Land Cover by Types Map Stand Boundary by Size Forest Land Timber Acres Harvested Tree Overstory Species Forest Open Land Percent Forest with Vegetation Forest Tree Point Occupancy Forested Wetlands by Type Tree Acres Planted Pct. Composition by Specie Groups Tree Specied Identification Woodland Comp. - Spec. Size Qual. Natural Timber Species Map Natural Hardwood Trees Map Natural Softwood Trees Poisonous Wild Trees Identify Grazable Woodland Location NFS Timber Land Use Classify
OTHER CATEGORIES: 3. Timber Volume 4. Forest Land Cover Condition 5. Grasses and Forbs 6. Shrubs 7. Fire Mapping 8. Monitoring Multipurpose Facility Use 9. Wilderness Land Use 10. Habitat Areas 11. Specific Conservation Practices	

As one might expect from the elements of the above lists, forestry is certainly the driver for high spatial resolution with many requirements for better than 10 meters. The IRS³ was unique in that 10 meters was for the first time acceptable from a policy perspective for spaceborne

sensors. Notwithstanding, forestry demands 2-5 meters for many applications (Fig. 4). In order to properly interpret "forestry" requirements the reader should add categories 3, 4, 7 and 8.

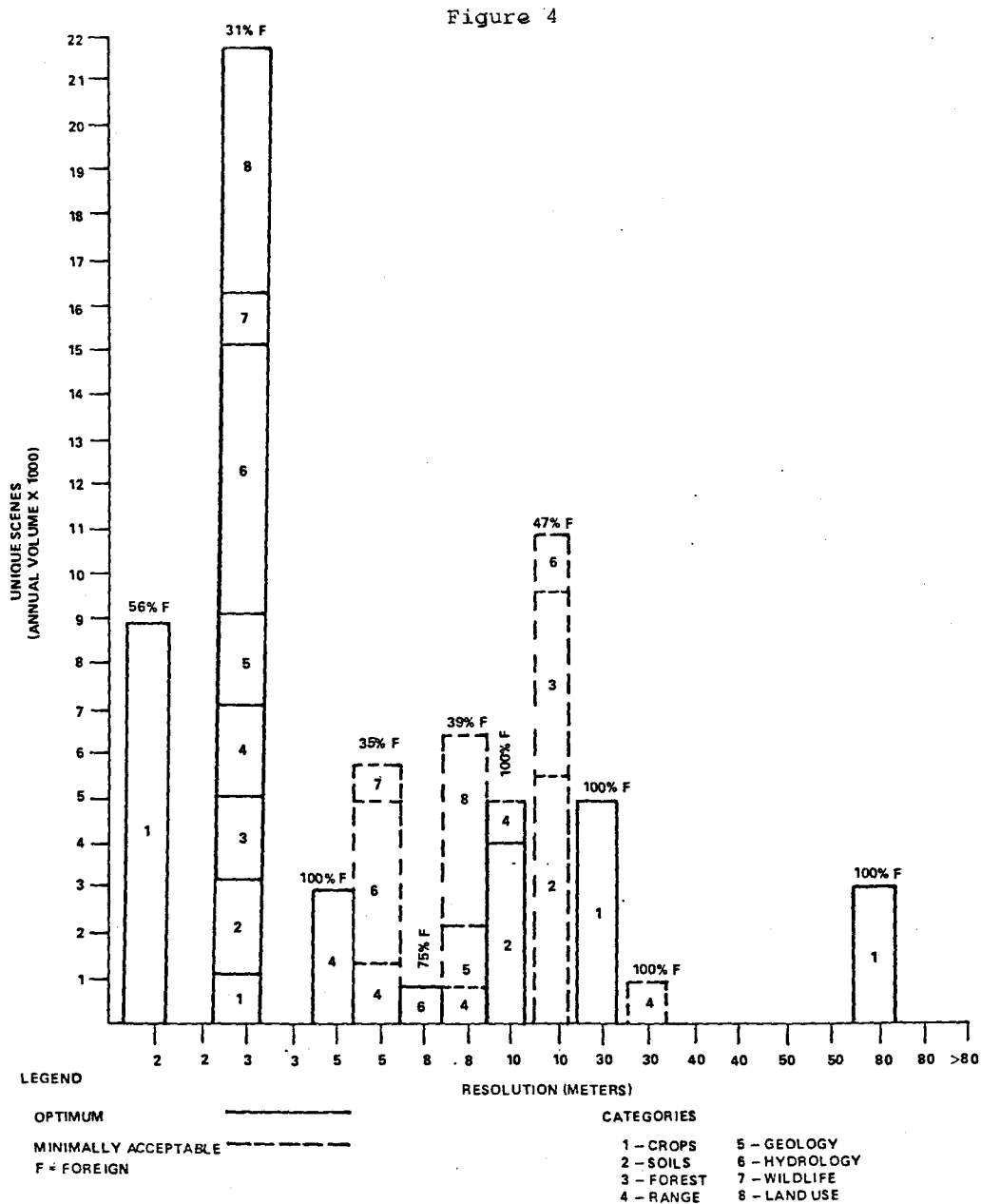

User Requirements for the USDA

One of the new capabilities being planned is that of stereo coverage. Those of us in the program since its inception will recall the reluctance we all felt in giving up stereo since it is such a valuable aid in classic photo interpretation. Unfortunately, the potential vertical precision of the planned system may not meet conventional requirements except for land form analysis and as an aid in terrain interpretation. During the time we have been using the planimetric Landsat a new tool has been made available - the digital terrain tapes from DMA. These tapes have been used successfully by many researchers to provide the Z dimension when merged with Landsat. Perhaps the most important use of these data has been as an additional discriminant (altitude), virtually doubling & tripling the number of clusters available for land cover classification. This of course includes forestry. Even though there are no official requirements for domestic stereo coverage, in the opinion of the author the current DMA tapes will not prove adequate for the improved resolution of the planned systems. If the resolution of the terrain tapes is improved commensurately, and available, then there may still be no domestic requirement for stereo for forestry. If, on the other hand, there is

no such DMA data available then the stereo will be valuable and will be used.

In terms of the future, the French and the Japanese governments are planning Earth Resource Missions. Both are comparable to Landsat-D in terms of spectral bands but they are pointable systems. The French system is able to point to any surface feature each 5 days. The nadir point would cross every feature each 26 days. This latter is due to the decreased FOV (two 60KM swaths accessible within 800KM). Figure 5 shows the requirements and limitations recommended by forestry on such systems. Recently G.E. studied a variety of advanced Earth Resource satellite systems in a study called Post Landsat D Advanced Concept Evaluation (PLACE). There, systems were designed as a result of a series of mission scenarios, one of which was forestry. Although the assumptions made by G.E. in the forestry mission were criticized as not representing the mission and goals of the Forest Service it should be noted that the mission scenario was used solely to provide technology drivers. It was assumed that type stand classification which involves quality as well as quantity of trees by species was the most demanding task for remote sensing. In addition, the new mission of the Forest Service, the Multiple Resource Inventory program was used as one of the drivers for the design of the large integrated data base.

Forestry
(Figure 5)

EIFOV (Meters on Ground)	Field of Coverage (KM)	Max Oblique Pointing Angle (Degrees)	Sample or Contiguous (S or C)
50-100	185 km	$\pm 12^\circ$ (one swath to right or left if nadir clouded in)	C or S (on disasters)
30-50	185 km	$\pm 12^\circ$ (two swath widths right or left) same as above	C or S depending on clouds at nadir
5-10	15-30 km	Keep within 185 km vertical image $\pm 6^\circ$	S

The following eight figures (Figures 6 through 13) illustrate the scope of the study in terms of the system concepts. The Landsat H system is familiar to most workers in the field and meets most of the requirements of the user community. Of much greater interest to the user community is the discussion in Figure 14.

All of these concepts were then subjected to a technology analysis. Most of the technology studies related to satellite subsystems such as power, precision pointing, very large structures etc., some were of great interest to the users. The Figure 15 discussion of on board processing and Figure 16 discussion of extractive processing are particularly relevant.



Figure 6
LANDSAT H - SYSTEM CONCEPT

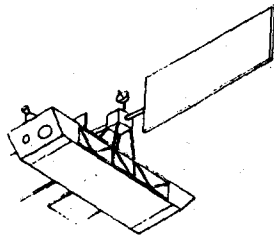

- SMART OPTICAL SENSOR ALLOWS FOR INTELLIGENT ON-BOARD EDITING/DATA REDUCTION
 - FORWARD/BACKWARD LOOKING
 - 10 M. RES., 10 BANDS, 185 KM SWATH
 - HRPI - 5 M RES. (5 KM)² TARGETS
- SAR PROVIDES ALL WEATHER IMAGING CAPABILITY
 - 25 M RES., L, C, X-BAND
- ACTIVE, VISIBLE SENSOR PROVIDES ATMOS. CAL., LUMINESCENCE, AND NIGHT IMAGING
 - SELECTABLE 3 KM SWATH
 - REQUIRES 300 KW AV. POWER DURING OPERATION
- ON-BOARD PROCESSING AND STORAGE ALLOWS FOR CHANGE DETECTION AND/OR INFORMATION EXTRACTION
- 3 SPACECRAFT - 6 DAY REPEAT CYCLE



Figure 7
EARTHWATCH - SYSTEM CONCEPT

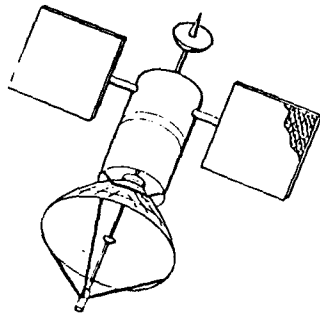

- INTERMEDIATE (SUBSYNCHRONOUS) ORBITS ORIGINALLY SUGGESTED BY ASTRONAUT BILL POGUE
- 5000-10,000 KM (8 HR.) REPEATING ORBITS - PROVIDE NEAR CONTINUOUS EARTH COVERAGE (8-12 SATELLITES - EL. > 20°)
- COULD PROVIDE BOTH EARTH RESOURCES MANAGEMENT INFORMATION (MAPPING) AND QUICK-LOOK CAPABILITY (DISASTER ASSESSMENT)
- POINTABLE OPTICAL SENSORS
 - HI-RES FOR QUICK-LOOK CAPABILITY - 3 M. RES - (5 KM)²
 - MED-RES FOR MAPPING CAPABILITY - 30 M. RES - (90 KM)²
- MICROWAVE SENSORS FREQUENCY SHARE ANTENNA
 - SAR - L, S, X-BAND - 10.25 M RES.
 - RADIOMETER - L, S, X-BAND - 12-120 KM RES.



GEOS - SYSTEM CONCEPT

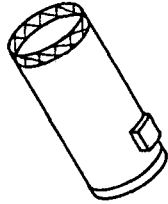

- LARGE EARTH-LOOKING TELESCOPE
 - SHORT-LIVED EVENTS, CONSTANT PERSPECTIVE
- 8 M DIAMETER PRIMARY OPTICS
 - MIRROR SEGMENTED, ADAPTIVE CONTROLS
- SENSOR IMAGES FROM VISIBLE TO THERMAL I.R.
 - 3 M IFOV IN VISIBLE
- (1650 ELEMENT)² 2-D FOCAL PLANE ARRAY
 - 2 μm ELEMENT SPACING
 - C.I.D.'s ALLOW SELECTIVE READOUT
- FOCAL LENGTH OF MIRROR IS 24 M

Figure 9



TEXTUROMETER - SYSTEM CONCEPT

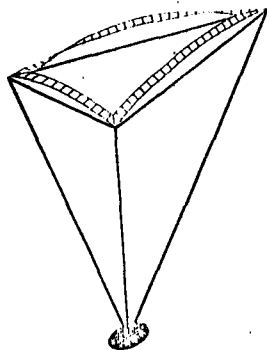

- MEASURES VISIBLE TEXTURE FROM 1 MM TO 1 M FROM 600 KM
- MIRROR FOCAL LENGTH = 600 M -- 100, 3 M MIRRORS/LINE
 - C.I.D. ARRAYS IN FOCAL PLANE
 - ADAPTIVE OPTICS FOR ATMOSPHERIC CORRECTION, FOCUS, POINTING
- COMPLEX PROCESSING REQUIRED
 - TOMOGRAPHIC APPROACH TO PIXEL SYNTHESIS
 - DATA TRANSFORMED TO SPATIAL FREQUENCY DOMAIN

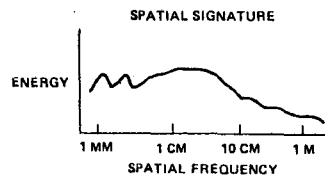
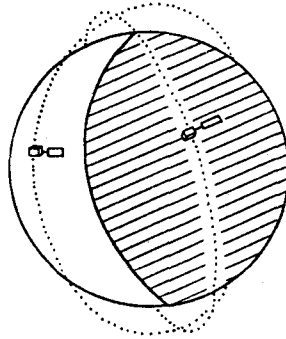

Figure 10



THERMAL INERTIA MAPPER - SYSTEM CONCEPT



- THERMAL MAPPER AS FOLLOW ON TO HCMM
- MEASURES THERMAL INERTIA OR HEAT CAPACITY OF TERRAIN
- SEQUENTIAL PASSES OVER SAME AREA
 - 4 A.M./10 A.M. - 4 P.M./10 P.M. LOCAL CROSSINGS
- 10 M RESOLUTION IN 8-13 μ m BAND
 - 600 KM ORBIT
 - 0.6 M DIAMETER PRIMARY OPTICS

Figure 11



MICROSAT - SYSTEM CONCEPT

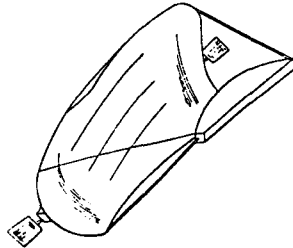

- PRIMARILY SOIL MOISTURE SENSOR
- L-BAND PASSIVE RADIOMETER
- PARABOLIC TORUS ANTENNA WITH CLUSTER OF FEED HORNS IN A FOCAL ARC
- FREQUENCY IS 1.4 GHZ (L BAND)
- ANTENNA SIZE APPROXIMATELY 600M X 1300M
- GROUND RESOLUTION - 1KM, ORBIT - 1000KM, REPEAT CYCLE - 3 DAYS (2 SPACECRAFT), RADIOMETRIC TEMP. RES. - 1°K

Figure 12



SWEEP FREQUENCY RADAR - SYSTEM CONCEPT

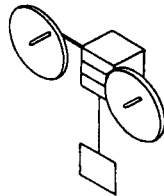

- RESULTANT TEXTURE IS ADDITIONAL PARAMETER FOR IDENTIFICATION AND CLASSIFICATION
- POLYCHROMATIC SCATTEROMETER FROM 30 MHZ TO 200 GHZ
- RESONANT BACKSCATTER INDICATES TEXTURE AT DISCRETE MEASUREMENTS FROM 1.5 MM TO 10 M
- 600 KM ORBIT - 10 M RES - 100 KM SWATH
- POWER VARIES FROM 1 W (AT 30 MHZ) TO 64 KW (200 GHZ)
- FREQUENCY ALLOCATION CONSIDERATIONS

Figure 13



GEOSYNCHRONOUS SAR - SYSTEM CONCEPT

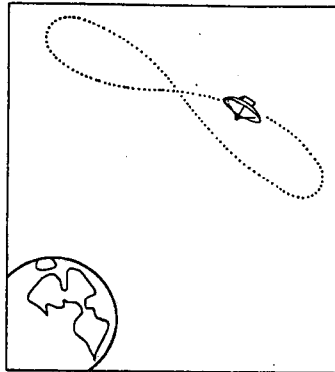

- PROVIDES RAPID-UPDATE RADAR IMAGING CAPABILITY
- SYSTEM USES THE NORTH-SOUTH DRIFT OF A GEOSYNCHRONOUS SPACECRAFT TO PROVIDE THE RANGE-RATE FOR A SYNTHETIC APERTURE
- THE SYSTEM MAPS FOOTPRINTS OF THE EARTH BY STARING AT THEM (INTEGRATING) FOR ABOUT 8 MINUTES
- TYPICAL ELEVATION ANGLES OF 30° - 60°
- APPROXIMATE TIME TO MAP THE ENTIRE U.S. IS 4-1/2 HRS.
- REPRESENTATIVE PERFORMANCE PARAMETERS
 - FREQUENCY = 2.5 GHZ - S-BAND
 - FOOTPRINT SIZE = 1050 KM x 650 KM
 - GROUND RESOLUTION = 100 M
 - AVERAGE RF POWER = 800 W
 - ANTENNA SIZE = 7.3 M DIAMETER
 - ORBIT INCLINATION ANGLE = 1°

Figure 14



FUTURE GROUND PROCESSING CONCEPT

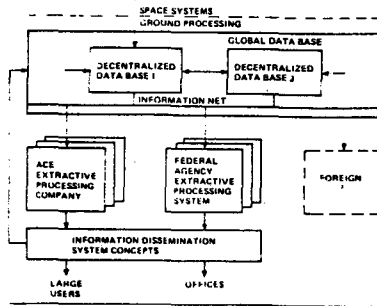

GLOBAL INFORMATION SYSTEM

REGIONALIZED & DISCIPLINE-SPECIFIC DATA BASES
 NOMINAL 10 M GRID - 300 OVERLAYS
 NETWORK PROVIDES NON-LOCAL ACCESSING

EXTRACTIVE INFORMATION PROCESSING SYSTEMS

EXISTING SIGNATURE BANK
 LIMITS OF SIGNATURE EXTENSION DEFINED
 MODELS - FORECASTS
 REMOTE SENSING DATA INCLUDES:

- VISIBLE I.R.
- MICROWAVE
- TEXTURE
- LUMINESCENCE

INFORMATION DISSEMINATION SYSTEMS

- COMSAT LINE TO LARGE USERS
- DIGITAL GROUND LINK TO OFFICES
 - INITIALLY VIA TV CABLE
 - LATER (1995) VIA PHONE LINK

Figure 15



**TECHNOLOGY REQUIREMENTS AND FORECAST
 ON-BOARD DATA STORAGE SYSTEMS**



REQUIREMENT

- ON BOARD DATA BASE TO SUPPORT LANDSAT H & GEOSAR PROCESSING REQUIREMENTS
- CAPACITY OF $5 \times 10^{12} - 10^{13}$ BITS. TRANSFER RATE OF 200 MBPS TO 1.0 GBPS

TECHNOLOGY PROJECTION

CURRENT	1985	1995
BUBBLE - 10^8 BITS/CHIP	BUBBLES - 10^8 BITS/IN ²	CAPACITY - BUBBLE - 100 mb/CHIP (IBM 10^6)
CCD - 64K BITS/CHIP	CCD - 10^8 BITS/CHIP	- CCD - 1 mb/CHIPS
MNOS - 64K BITS/CHIP		- MNOS - HARD TO MAKE HARD - 256K BITS/CHIP
E-BEAM - 64M BIT SYSTEM		SPEED - ECL
		- GAAI

NASA DEVELOPMENT REQUIRED

- BUBBLE RADIATION HARDNESS EVALUATION
- SERIAL READ/WRITE SYSTEM AND CIRCUIT DESIGN

EXTERNAL TECHNOLOGY DRIVERS

TRANSFER RATES - COMMERCIAL AND MILITARY COMPUTATIONAL SPEED OF ELECTRONIC SYSTEMS
 STRONG COMMERCIAL BUBBLE MARKET

Figure 16



TECHNOLOGY REQUIREMENTS AND FORECAST
EXTRACTIVE PROCESSING



REQUIREMENT

FOR EACH OF THE KEY SET OBJECTIVES, THE TECHNOLOGY REQUIRED TO OPERATIONALLY TRANSFORM REMOTE SENSING MEASUREMENTS INTO USABLE INFORMATION MUST BE ACHIEVED

TECHNOLOGY PROJECTION

	<u>CURRENT</u>	<u>1995</u>
SIGNATURE BANK		
- MSMTS. OVER TIME	FIELD MSMTS. PROGRAM	WORLD ECOZONE MAP COMPLETED
- 4μ m TO 10 μ m		R.S. MSMTS. RELATED TO PLANT PHYSIOLOGY
- PER ECOZONE		
- PER IDENTIFIABLE CLASS		
SIGNATURE EXTENSION	ERIM	ONGOING-UNCERTAINTIES REDUCED
MODELS	EXTENSIVE HYDROLOGIC SEVERAL CROP MODELS CENSUS CITES NOMOGRAM	EXECUTING CONTINUING REFINEMENT
FORECASTS	EARLY ACTIVITY	CONTINUING IMPROVEMENT
ABILITY ENHANCED BY MODELS		

NASA DEVELOPMENT REQUIRED

- CONTINUED RESEARCH IN RELATING PHENOMENA TO OBSERVABLES
- EXPANDED FIELD MSMTS. PROGRAM
- GLOBAL ECOZONE MAPPING - DEFINE LIMITS OF EXTENDABILITY
- CONTINUED MODELING RESEARCH - PLANT PHYSIOLOGY, DEMOGRAPHY, HYDROLOGY, GEOLOGIC STRUCTURE, EPISODIC EVENTS

EXTERNAL TECHNOLOGY DRIVERS

- GLOBAL INFORMATION SYSTEM (AGENCY) AND "DISCIPLINE" ORIENTED FEDERAL AGENCIES ARE JOINT PARTNERS WITH NASA IN THIS ACTIVITY
- INTERNATIONAL AGENCIES (FAO), INSTITUTIONS (ROCKERFELLER) AND PERHAPS AGRIBUSINESS WILL PROVIDE ASSISTANCE IN MODELING AND FIELD PROGRAMS

SUMMARY

Forestry has been and continues to be a driver of technology. It is significant to note that in the summary discussion of information extraction systems (Fig 16) that the driver was a 1995 deadline on a complete ecozone map of the world. While it is true that there is a perceived need but no current budget to support such a global data base it seems reasonable to forecast such a requirement and to design systems to support it.